

ROTEL®

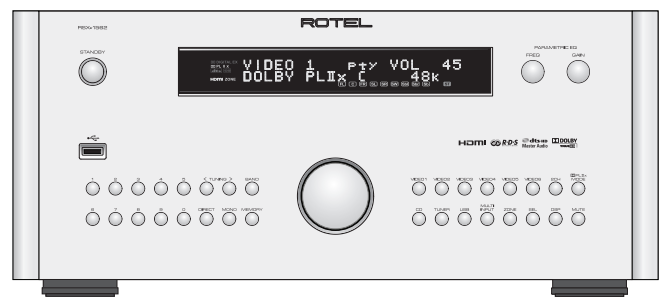





















































RSX-1562 Surround Sound Receiver

Owner's Manual
Manuel de l'utilisateur
Bedienungsanleitung
Manual de Instrucciones
Gebruiksaanwijzing
Manuale di istruzioni
Instruktionsbok
Инструкция пользователя

Register your product at
www.rotel.com/register

Contents

Important Safety Instructions	5	Connecting DVD-A or SACD Player	24
Figure 1: Control and Connections	6	Connecting Video Recorder	24
Figure 2: Remote Control	7	Connecting CD Player	24
Figure 3: Connecting the Speakers	8	Connecting Audio Recorder	24
Figure 4: Monitor, Video recording Connections	9	Connecting USB Audio/iPod/iPhone	25
Figure 5: DVD, Blu-ray Player and Cable, Satellite, HDTV tuner Connections	10	Zone Outputs (ZONE 2,3,4)	25
Figure 6: DVD-A or SACD Player Connections	10	Operating the RSX-1562	25
Figure 7: Video Recorder Connections	11	Front Panel Overview	25
Figure 8: CD Player Connections	11	Front Panel Display 	25
Figure 9: Audio Recorder Connections	12	Remote Sensor 	25
Figure 10: AM and FM Antenna Connections	12	Remote Control Overview	25
Figure 11: USB Audio/iPod Connections	13	Overview of Buttons and Controls	26
Figure 12: Zone Connection	14	STANDBY  and Power ON/OFF Buttons 	26
On-Screen Menus	15	VOLUME Knob and VOLUME +/- Buttons  	26
About Rotel	16	DISPLAY (DISP) Button 	26
Getting Started	16	RCVR SETUP Button 	26
Video Features	16	Navigating and Select (ENT) keys 	26
Audio Features	16	MUTE Button 	26
Surround Features	16	INPUT Buttons   	26
Other features	17	ZONE Button 	26
Unpacking	17	SEL Button 	26
Placement	17	MODE buttons   SUR+ 	26
Overview of Connections	18	Playback buttons 	26
Video Inputs and Outputs	18	RND Button 	26
HDMI IN 1–6 Video Inputs 	18	P-EQ Button/Knobs 	26
COMPOSITE IN 1–2 Video Inputs 	18	SPKR Button 	26
COMPOSITE Video Output 	18	MEM Button 	26
COMPONENT VIDEO 1–2	18	Party Mode: Selecting the Same input for all outputs  	26
Video Inputs 	18	SURROUND SOUND	27
COMPONENT Video output 	18	Overview of Surround Format	27
High Definition TV Monitor Outputs 	20	Dolby Surround & Dolby Pro Logic II	27
HDMI Monitor Outputs 	20	Dolby Digital	27
Audio Inputs and Outputs	20	DTS 5.1 & DTS 96/24	27
VIDEO 1–6 Audio Inputs 	20	DTS Neo:6	28
VIDEO Out Audio Output 	20	Dolby Digital Surround EX	28
CD Inputs 	20	DTS-ES 6.1 and 7.1 Channel Surround	28
MULTI Inputs 	20	Dolby Pro Logic IIx 6.1 and 7.1 Channel Surround	28
Preamp Outputs 	20	Dolby Pro Logic IIz 7.1 Height Surround	28
Digital Inputs 	20	Rotel XS 6.1 and 7.1 Channel Surround	28
Digital Outputs 	21	Dolby Digital Plus	28
USB Audio Connection 	21	Dolby True HD	28
Other Connections	21	DTS-HD Master Audio &	28
AC Input 	21	DTS-HD High Resolution Audio	28
Master Power Switch 	21	DSP Music Modes	28
12V TRIGGER Connections 	21	2CH/5CH/7CH stereo formats	29
REM IN Jacks 	21	Other Digital Formats	29
IR OUT Jacks 	22	Automatic Surround Modes	30
Rear Mini USB Socket 	22	Manually Selecting Surround Modes	30
Remote IR OUT 	22	Dolby Digital/TrueHD discs	31
Computer I/O 	22	Dolby Digital Surround EX discs	31
MAKING CONNECTIONS	22	Dolby Digital 2.0 discs	31
Connecting Speakers 	22	DTS/DTS-HD 5.1 discs	31
Connecting a Subwoofer 	23	DTS 96/24 discs	31
Amplifiers 	23	DTS-ES 6.1 discs	31
AM Antenna 	23	Digital Stereo discs	32
FM Antenna 	23	Analog Stereo	32
Connecting Monitor	23	BASIC OPERATIONS	33
---HDTV Monitor/Video Recording	23	Selecting Inputs	33
Connecting DVD, Blu-ray Player and Cable, Satellite, HDTV tuner	23	Remote Zone Operation	33
		Remote Zone Power On/Off	33
		Controlling Zones 2- 4 from the Main Room	34

Controlling Zones 2 - 4 from Remote Locations	34
USB/iPod operation	34
USB Storage Device Connection 1	34
iPod/iPhone Connection 1	34
PlayBack Control Buttons L	34
USB Bluetooth	35
USB Bluetooth dongle connection	35
SETUP	35
Menu Basics	35
Navigation Buttons	35
System Status	36
Main Menu	36
Configuring Inputs	36
Input Setup	36
Multi Input Setup	38
Dolby Pro Logic IIx	38
DTS Neo:6	38
Configuring Speakers and Audio	39
Speaker Setup	40
Advanced Speaker Setup	40
Subwoofer Setup	41
Test Tone Setup	42
Delay Setup	42
Tuner Controls	43
BAND Buttons 4 K	43
TUNING Buttons 10 L	43
MEMORY Button 12 H	43
NUMERIC Buttons : Station Presets 12 B H G	43
DIRECT Button 9	43
FRQ-D Button ("10+" key) H	43
MONO Button 11	44
RDS and RBDS Tuning	44
DISP Button D	44
PTY Button K	44
Miscellaneous Settings	45
Other Options	45
Video/HDMI SETUP	45
Zone 2-4 Setup	46
Default Setup	46
EQ Setup	47
Troubleshooting	48
HDMI: Frequently Asked Questions	49
What is HDMI?	49
What is the difference between HDMI and DVI?	49
What is the difference between HDMI 1.4, HDMI 1.3 and earlier versions?	49
Can I connect components which have earlier versions of HDMI?	49
Which is the best way to rescale the picture?	49
Will the HDMI digital output improve the picture quality from old analog sources?	49
Why does the HDMI connection sometimes not give a picture?	49
Specifications	50

CAUTION

RISK OF ELECTRIC SHOCK

DO NOT OPEN

CAUTION: TO REDUCE THE RISK OF ELECTRIC SHOCK, DO NOT REMOVE COVER. NO USER-SERVICEABLE PARTS INSIDE REFER SERVICING TO QUALIFIED SERVICE PERSONNEL.

This symbol is to alert the user to the presence of uninsulated dangerous voltages inside the product's enclosure that may constitute a risk of electric shock.

This symbol is to alert the user to important operating and maintenance (service) instructions in this manual and literature accompanying the product.

APPLICABLE FOR USA, CANADA OR WHERE APPROVED FOR THE USAGE

CAUTION: TO PREVENT ELECTRIC SHOCK, MATCH WIDE BLADE OF PLUG TO WIDE SLOT. INSERT FULLY.

ATTENTION: POUR EVITER LES CHOCS ELECTRIQUES, INTRODUIRE LA LAME LA PLUS LARGE DE LA FICHE DANS LA BORNE CORRESPONDANTE DE LA PRISE ET POUSSER JUSQU'AU FOND.

This Class B digital apparatus complies with Canadian ICES-003.

Cet appareil numérique de la classe B est conforme à la norme NMB-003 du Canada.

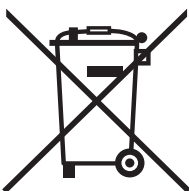

Rotel products are designed to comply with international directives on the Restriction of Hazardous Substances (RoHS) in electrical and electronic equipment and the disposal of Waste Electrical and Electronic Equipment (WEEE). The crossed wheelie bin symbol indicates compliance and that the products must be appropriately recycled or processed in accordance with these directives.

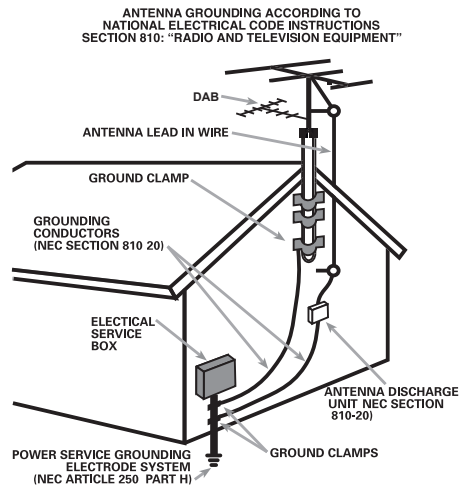
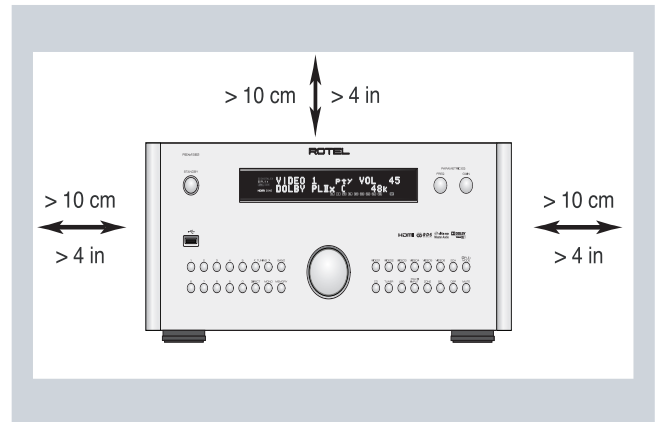

Notice

The COMPUTER I/O connection should be handled by authorized persons only.

FCC Information

This equipment has been tested and found to comply with the limits for a Class B digital device, pursuant to Part 15 of the FCC Rules. These limits are designed to provide reasonable protection against harmful interference in a residential installation. This equipment generates, uses and can radiate radio frequency energy and, if not installed and used in accordance with the instruction, may cause harmful interference to radio communications.

However, there is no guarantee that interference will not occur in a particular installation. If this equipment does cause harmful interference to radio or television reception, which can be determined by turning the equipment off and on, the user is encouraged to try to correct the interference by one or more of the following measures:

- Reorient or relocate the receiving antenna.(TV, radio, etc.)
- Increase the separation between the equipment and receiver
- Connect the equipment to an outlet on circuit different from that to which the receiver is connected.
- Consult the dealer or an experienced radio/TV technician for additional help.

Caution

This device complies with part 15 of the FCC Rules. Operation is subject to the following to conditions: (1) This device may not cause harmful interference, and (2) this device must accept any interference received, including interference that may cause undesired operation.

Some products are intended for sale in more than one country and as such are supplied with more than one power cable. Use only the type applicable to your country. If in doubt please consult with your authorized Rotel dealer. r

NOTE TO CATV SYSTEM INSTALLER: Call the CATV system or antenna installer's attention to Article 820-40 of the NEC. This provides guidelines for proper grounding and, in particular, specifies that the cable ground shall be connected to the grounding system of the building, as close to the point of cable entry as practical. See installation diagram.

NOTE: This equipment has been tested and found to comply with the limits for a Class B digital device, pursuant to Part 15 of the FCC Rules. These limits are designed to provide reasonable protection against interference in a residential installation. This equipment generates and can radiate radio frequency energy and, if not installed and used in accordance with the instructions, may cause interference to radio or TV communications. There is no guarantee that interference will not occur in a particular installation. If this equipment does cause interference to radio or television reception, which can be determined by turning the equipment off and on, try to correct the interference by one or more of the following measures:

- Reorient or relocate the receiving antenna.
- Increase the separation between the unit and the television tuner.
- Connect the unit to an AC power outlet on a different electrical circuit.
- Consult your authorized Rotel retailer for assistance.

Important Safety Instructions

WARNING: There are no user serviceable parts inside. Refer all servicing to qualified service personnel.

WARNING: To reduce the risk of fire or electric shock, do not expose the unit to moisture or water. Do not expose the unit to dripping or splashing. Do not place objects filled with liquids, such as vases, on the unit. Do not allow foreign objects to get into the enclosure. If the unit is exposed to moisture, or a foreign object gets into the enclosure, immediately disconnect the power cord from the wall. Take the unit to a qualified service person for inspection and necessary repairs.

Read all the instructions before connecting or operating the component.

Keep this manual so you can refer to these safety instructions.

Heed all warnings and safety information in these instructions and on the product itself. Follow all operating instructions.

Clean the enclosure only with a dry cloth or a vacuum cleaner.

Do not use this unit near water.

You must allow a minimum 10 cm or 4 inches of unobstructed clearance around the unit.

Do not place the unit on a bed, sofa, rug, or similar surface that could block the ventilation openings. If the unit is placed in a bookcase or cabinet, there must be ventilation of the cabinet to allow proper cooling.

Keep the component away from radiators, heat registers, stoves, or any other appliance that produces heat.

WARNING: The rear panel power cord connector is the mains power disconnect device. The apparatus must be located in an open area that allows access to the cord connector.

The unit must be connected to a power supply only of the type and voltage specified on the rear panel. (USA: 120 V/60Hz, EC: 230V/50Hz)

Connect the component to the power outlet only with the supplied power supply cable or an exact equivalent. Do not modify the supplied cable. A polarized plug has two blades, with one wider than the other. A grounding plug has two blades plus a third grounding prong. These are provided for your safety. Do not defeat grounding and/or polarization safety provisions. If the supplied plug does not fit your outlet, please consult an electrician for replacement of the obsolete outlet. Do not use extension cords.

The main plug of the power cord set is a disconnect device of the apparatus. In order to completely disconnect the apparatus from the supply mains, the main plug of the power cord set should be unplugged from the mains (AC) outlet. The stand-by LED indicator will not be lit up to show the power cord is unplugged. The disconnect device shall remain readily operable.

Do not route the power cord where it will be crushed, pinched, bent, exposed to heat, or damaged in any way. Pay particular attention to the power cord at the plug and where the cord exits the back of the unit.

Main plug is used as the main disconnect device and shall remain ready accessible.

The power cord should be unplugged from the wall outlet during a lightning storm or if the unit is to be left unused for a long period of time.

Use only accessories specified by the manufacturer.

Use only with a cart, stand, rack, bracket or shelf system recommended by Rotel. Use caution when moving the unit in a stand or rack to avoid injury from a tip-over.

Use Class 2 wiring for speaker connections to ensure proper installation and minimize the risk of electrical shock.

Immediately stop using the component and have it inspected and/or serviced by a qualified service agency if:

- The power supply cord or plug has been damaged
- Objects have fallen or liquid has been spilled into the unit
- The unit has been exposed to rain
- The unit shows signs of improper operation
- The unit has been dropped or damaged in any way

The batteries in remote control shall not be exposed to excessive heat such as sunshine, fire or the like.

WARNING: The master power switch is located on the rear panel. The unit must allow unobstructed access to the main power switch.

Figure 1: Control and Connections

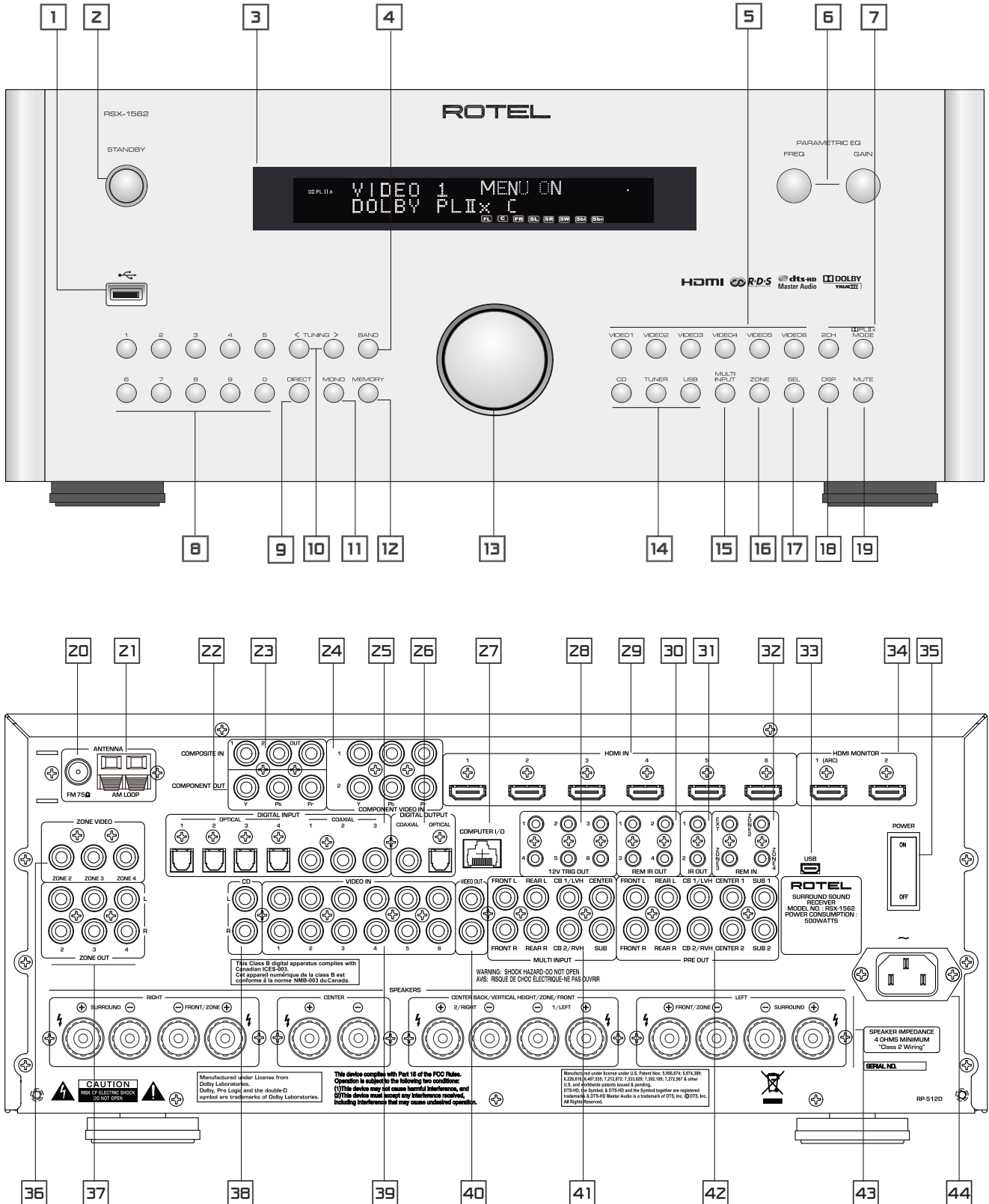

Figure 2: Remote Control

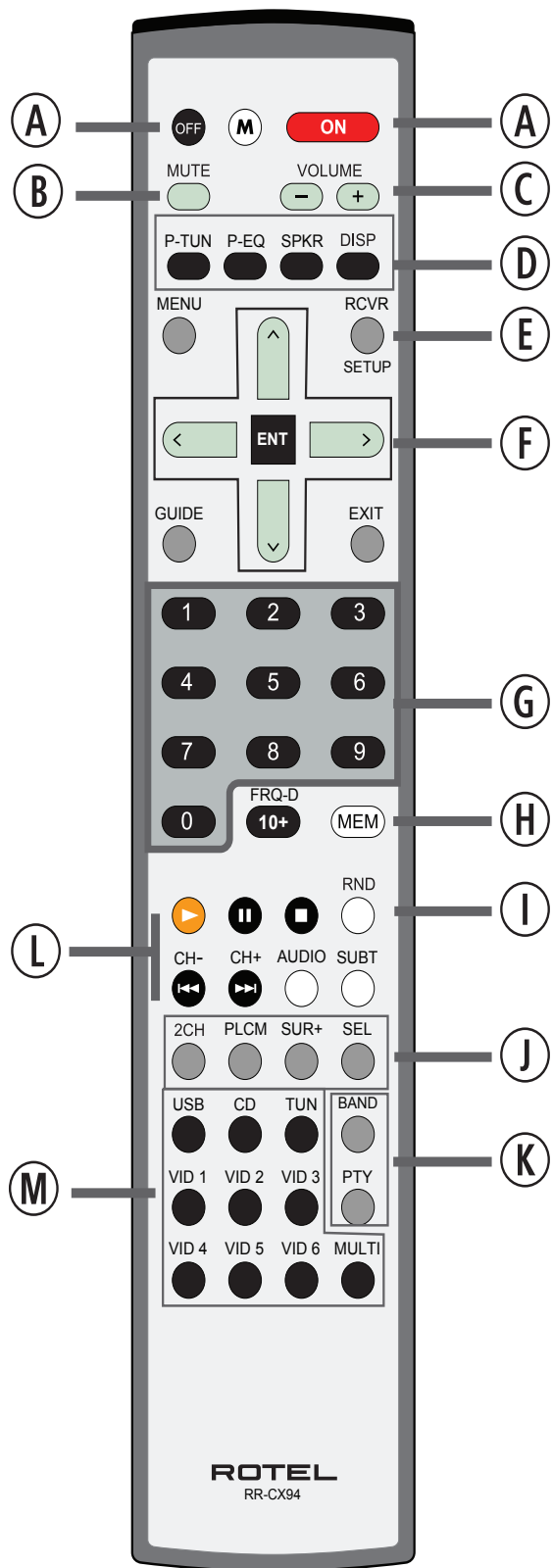

Figure 3: Connecting the Speakers

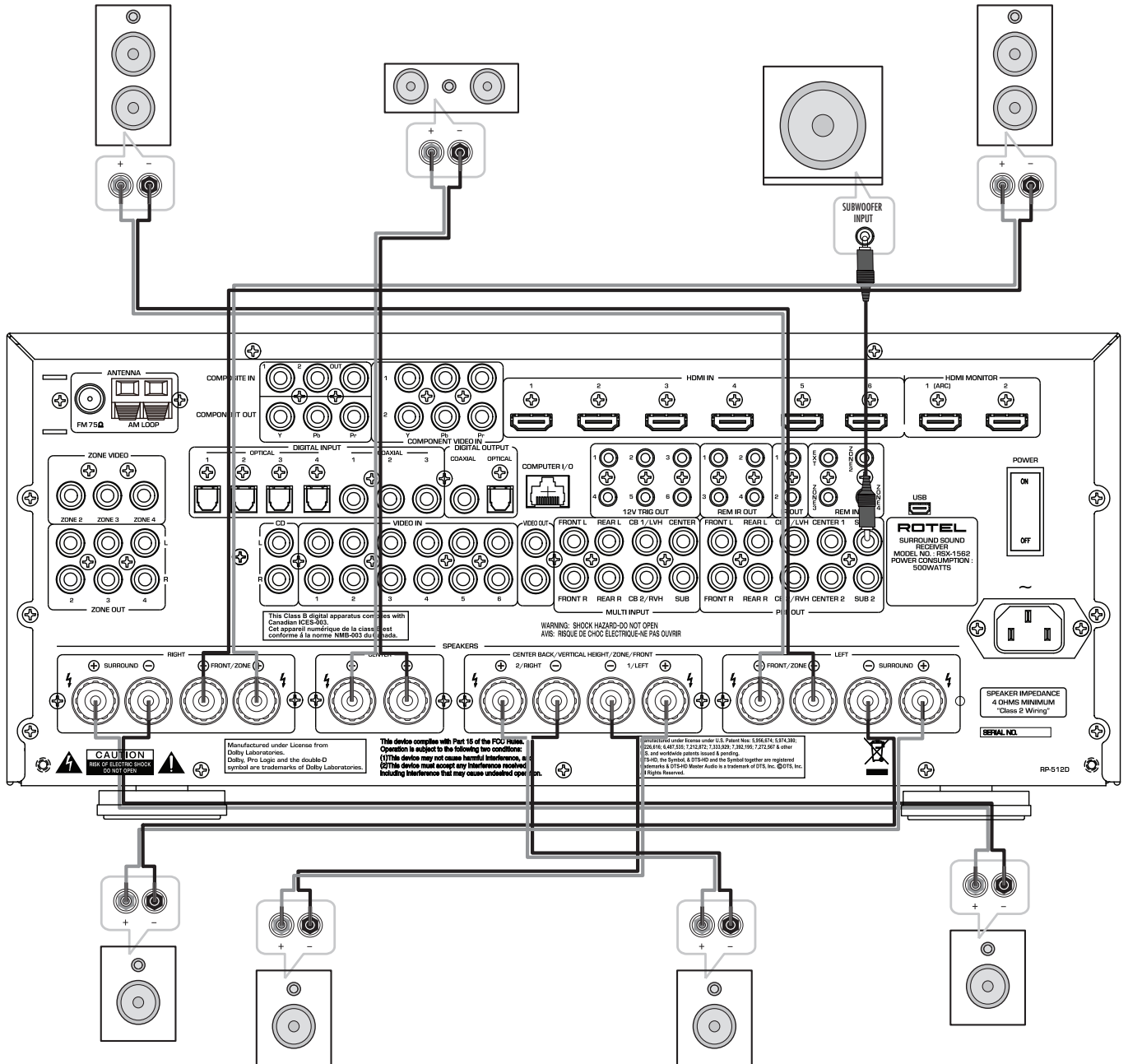

Figure 4: Monitor, Video recording Connections

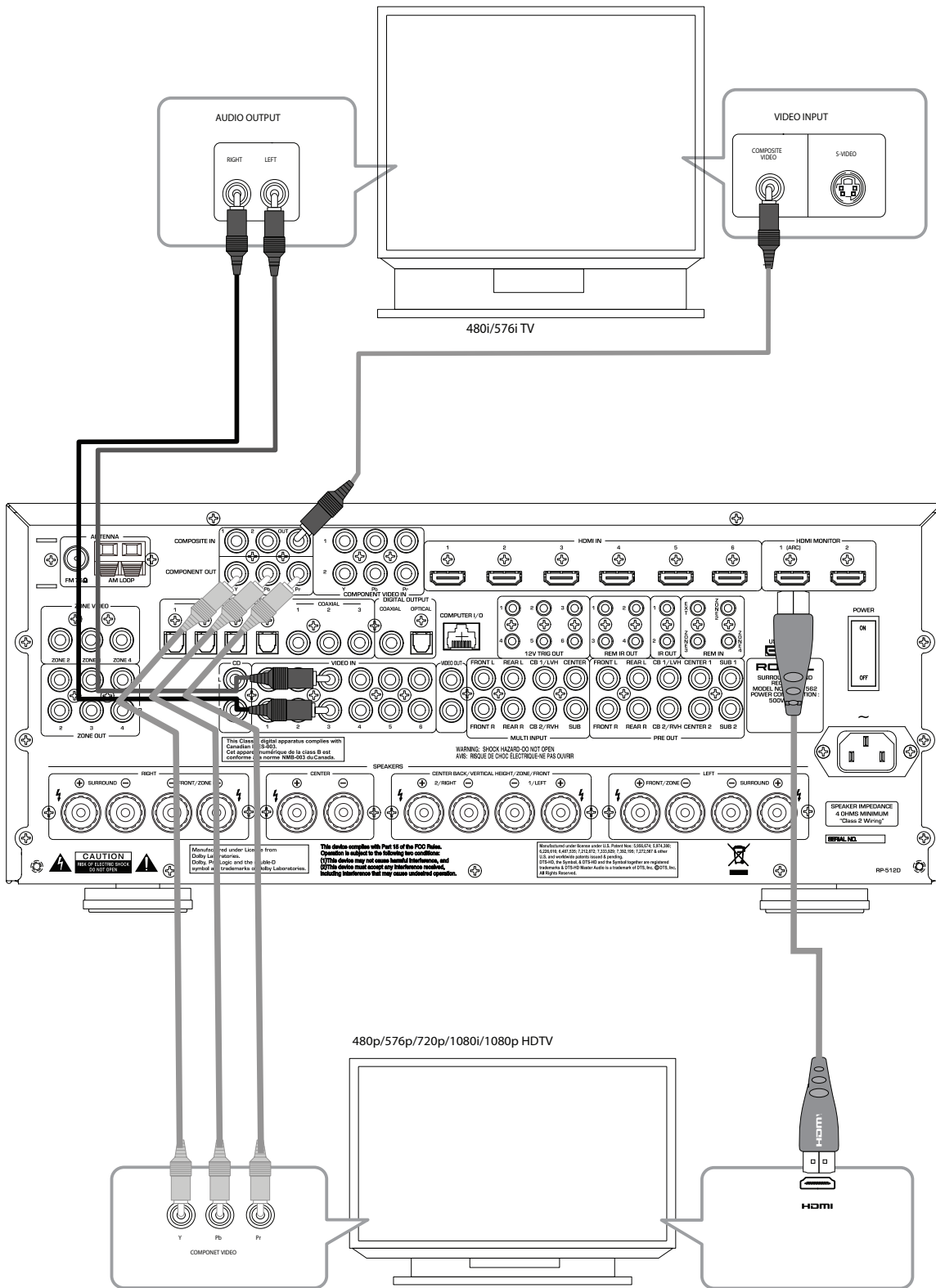

Figure 5: DVD, Blu-ray Player and Cable, Satellite, HDTV tuner Connections

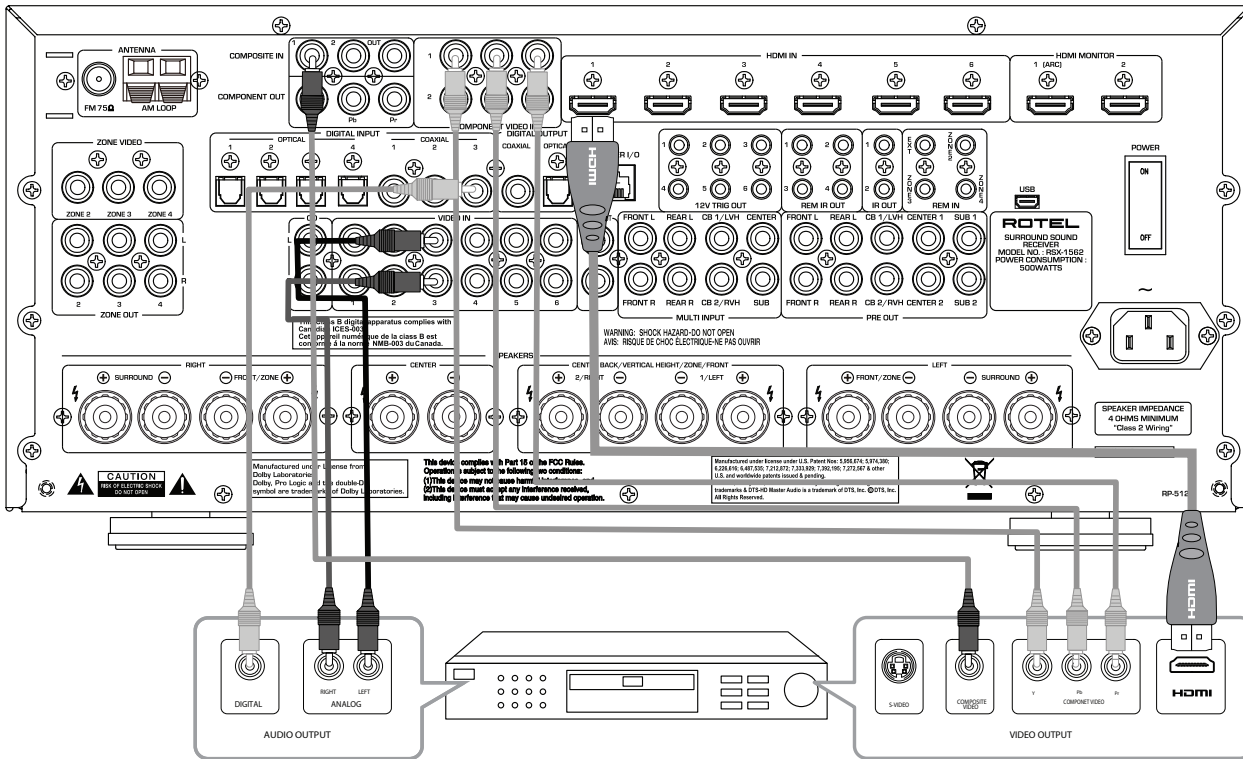

Figure 6: DVD-A or SACD Player Connections

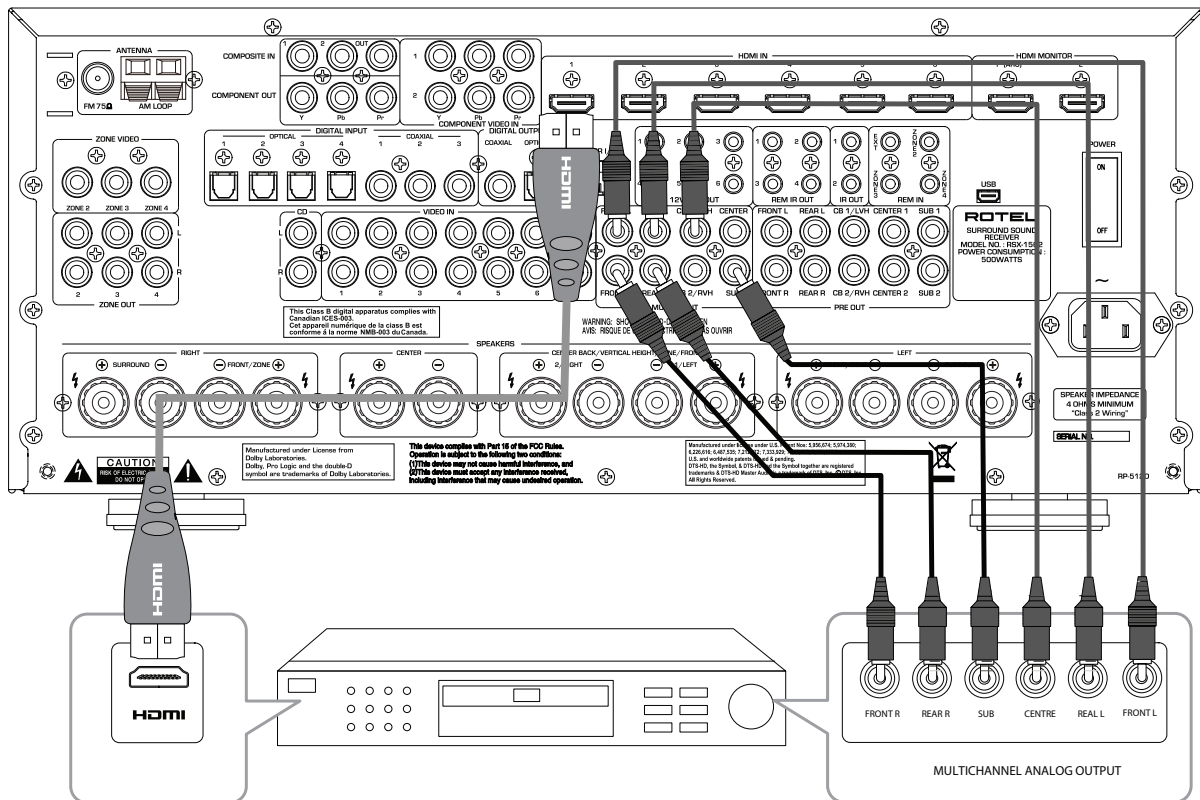

Figure 7: Video Recorder Connections

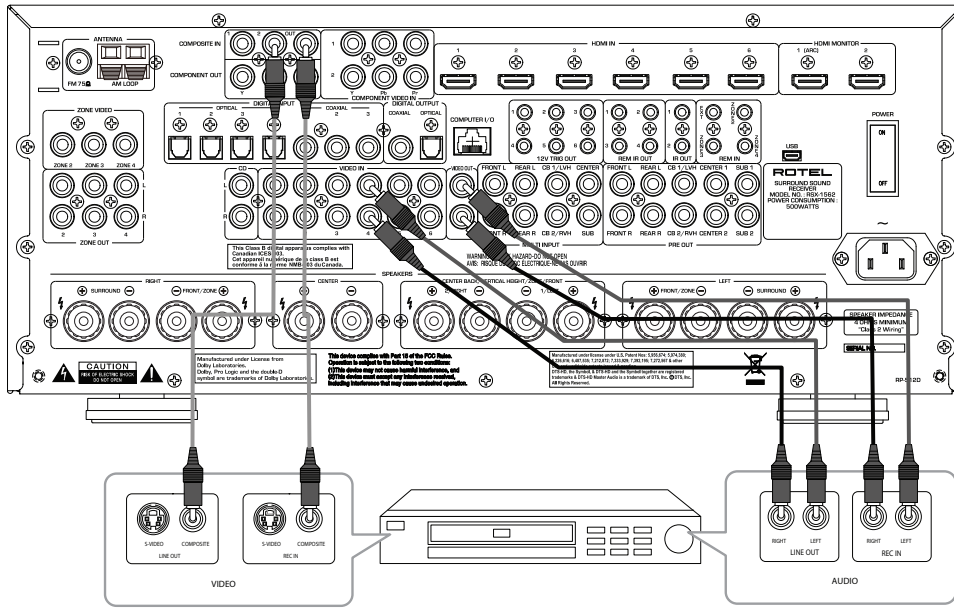

Figure 8: CD Player Connections

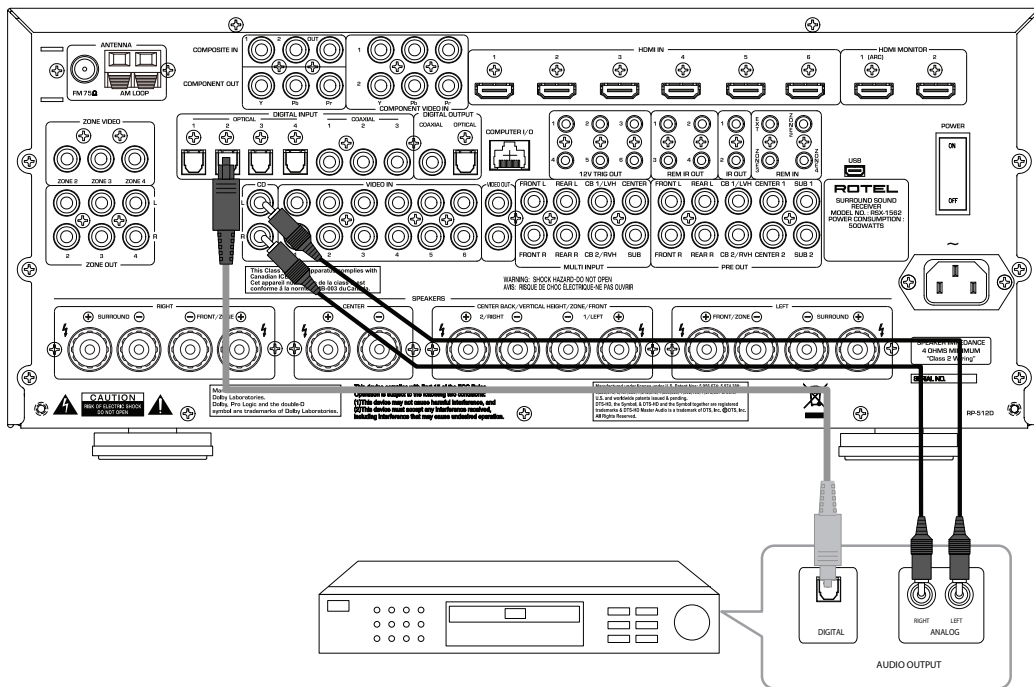

Figure 9: Audio Recorder Connections

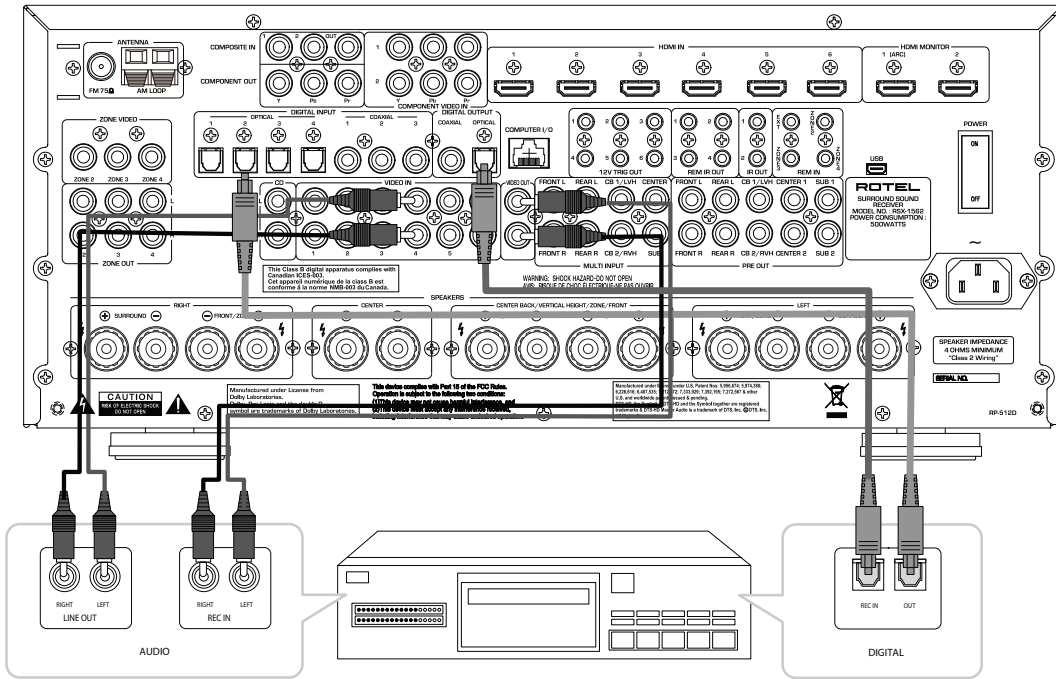

Figure 10: AM and FM Antenna Connections

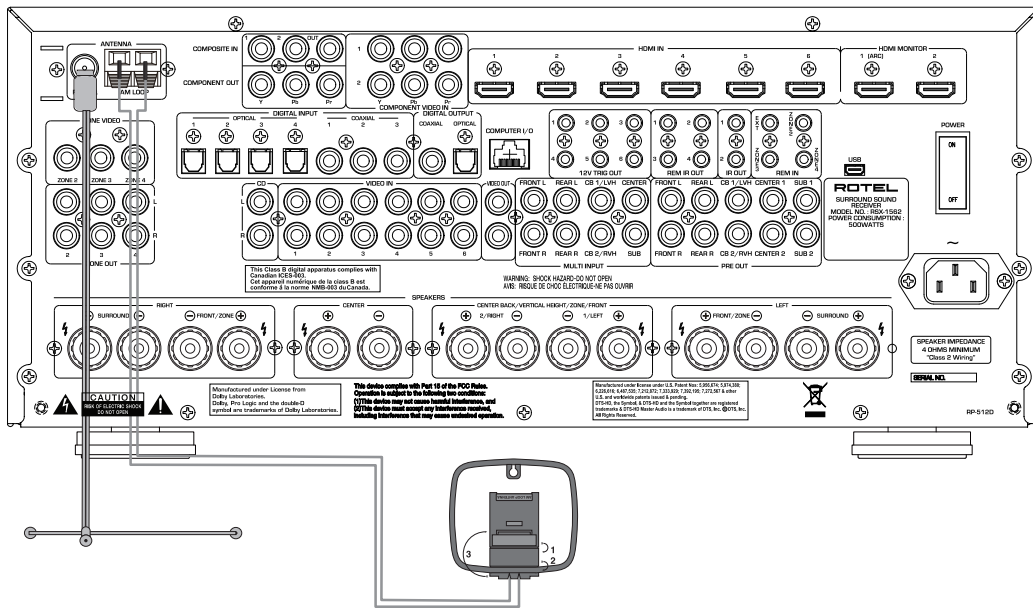

Figure 11: USB Audio /iPod Connections

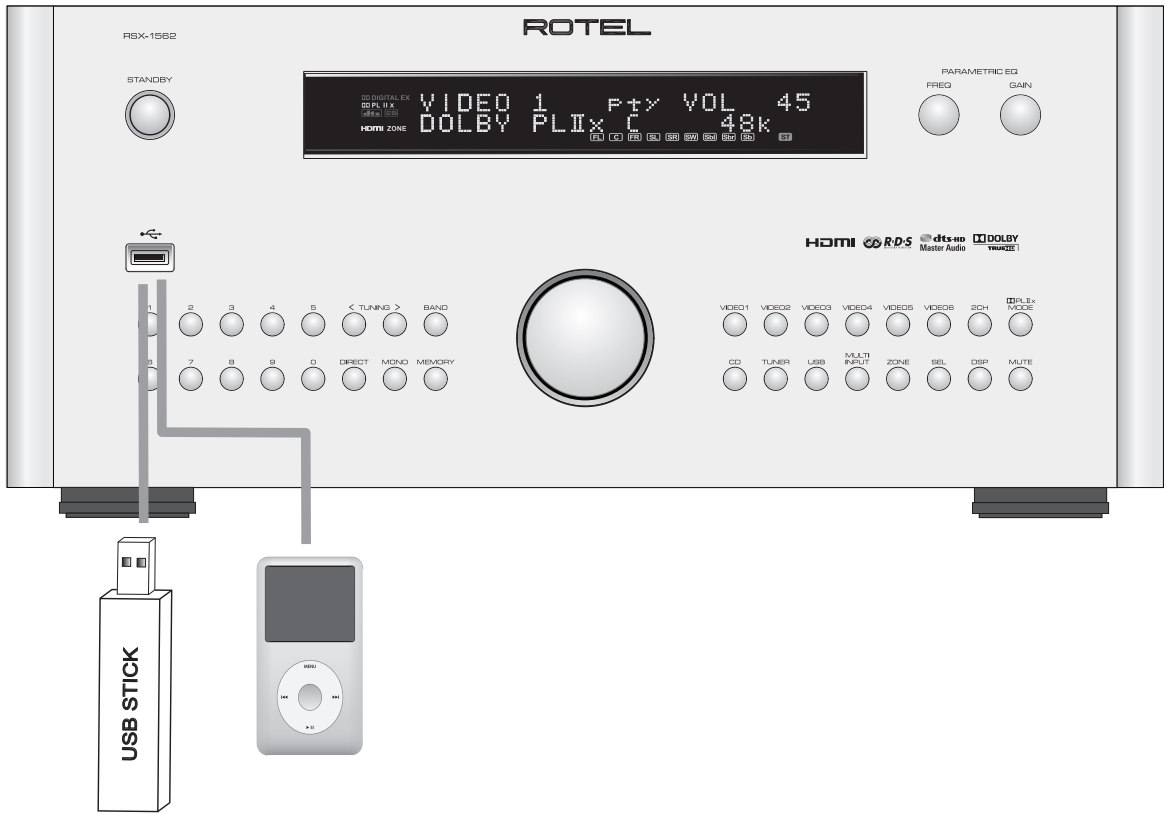
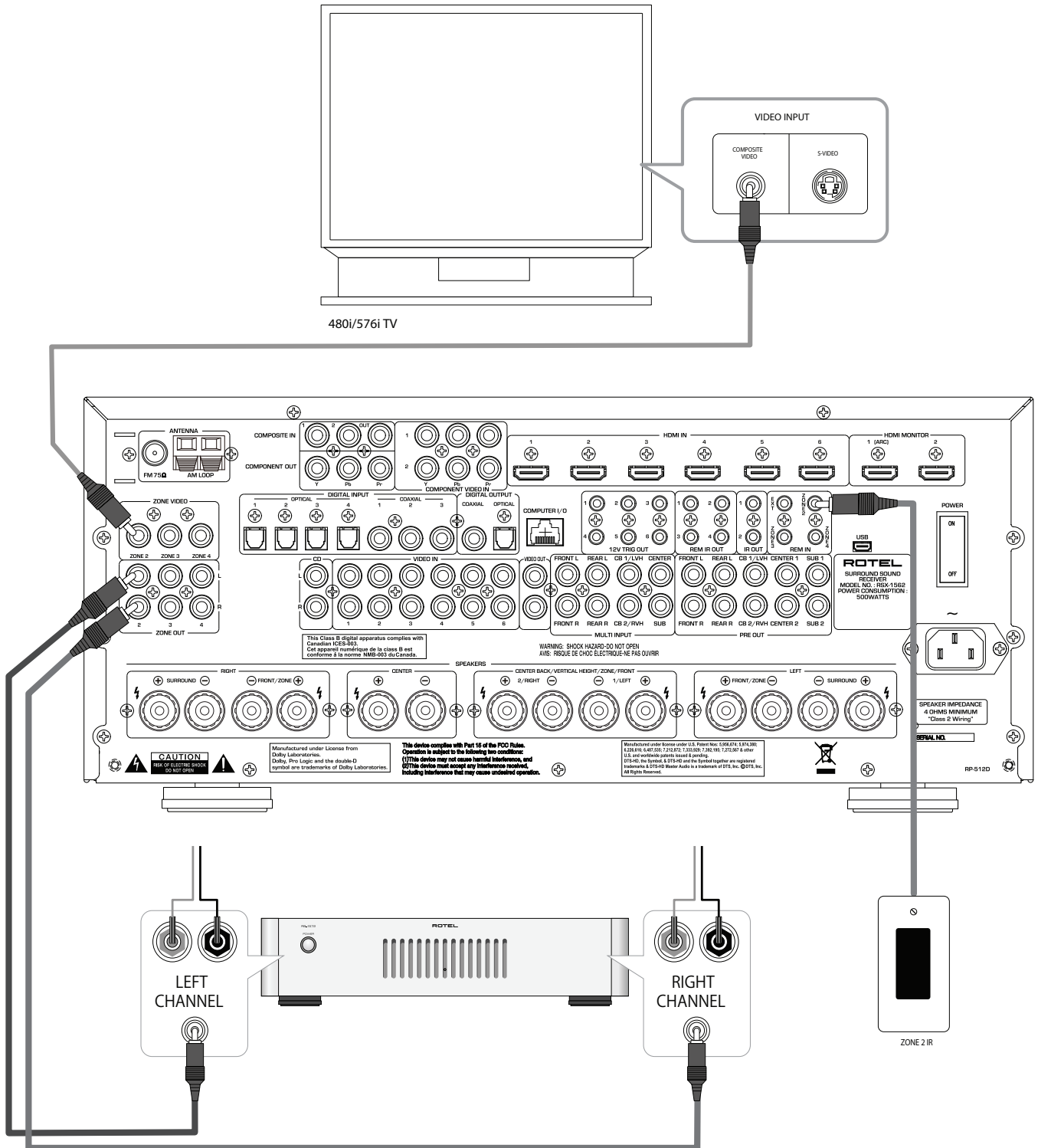
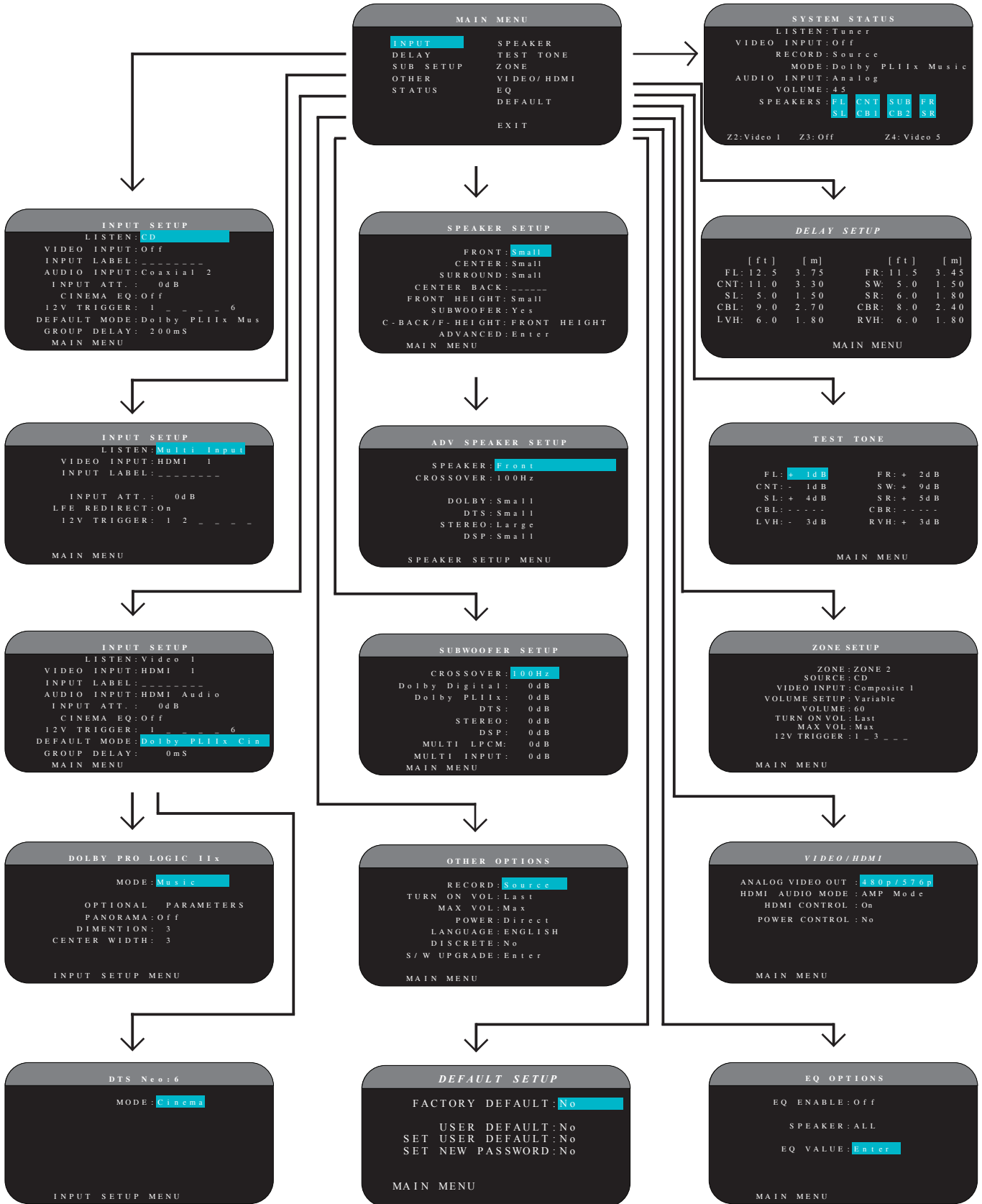

Figure 12: Zone Connection



On-Screen Menus



About Rotel

Our story began 50 years ago. Over the decades, we have received hundreds of awards for our products and satisfied hundreds of thousands of people who take their entertainment seriously- like you!

Rotel was founded by a family whose passionate interest in music led them to manufacture high-fidelity components of uncompromising quality. Through the years, that passion has remained undiminished and the family goal of providing exceptional value for audiophiles and music lovers, regardless of their budget, is shared by all Rotel employees.

Rotel's engineers work as a close team, listening to, and fine tuning, each new product until it reaches their exacting musical standards. They are free to choose components from around the world in order to make that product the best they can. You are likely to find capacitors from the United Kingdom and Germany, semiconductors from Japan or the United States, while toroidal power transformers are manufactured in Rotel's own factory.

We all have concerns about our environment. And, as more and more electronics are produced and later discarded, it is especially important for a manufacturer to do all it can to engineer products that have a minimum negative impact on landfill sites and water tables.

At Rotel, we are proud to do our part. We have reduced the lead content in our electronics by using special RoHS solder, while our new Class D (not digital) amplifiers are up to five times more efficient than our legacy designs and still deliver power and performance. These products run cool, give minimum wasted energy, are good for the environment and give better sound too.

Finally, we have printed this brochure on recycled paper stock.

While we understand that these are small first steps, they are still important ones. And we continue to pursue new methods and materials for a cleaner and greener manufacturing process.

All of us at Rotel thank you for buying this product. We are sure it will bring you many years of enjoyment.

Manufactured under license from Dolby Laboratories. Dolby, Pro Logic and the double-D symbol are trademarks of Dolby Laboratories. Copyright 1995-2005. All rights reserved.

Manufactured under license under U.S. Patent #'s: 5,451,942; 5,956,674; 5,974,380; 5,978,762; 6,226,616; 6,487,535; 7,212,872; 7,333,929; 7,392,195; 7,272,567 & other U.S. and worldwide patents issued & pending. DTS, DTS-HD and the Symbol are registered trademarks, & DTS-HD Master Audio, and the DTS logos are trademarks of DTS, Inc. Product includes software. © DTS, Inc. All Rights Reserved.

This item incorporates copy protection technology that is protected by U.S. patents and other intellectual property rights of Rovi Corporation. Reverse engineering and disassembly are prohibited.

Getting Started

Thank you for purchasing the Rotel RSX-1562 Surround Sound Receiver. The unit is a full-featured audio/video control center for analog and digital source components. It features digital processing for a wide range of formats including Dolby Surround®, Dolby Digital® and DTS® source material.

Video Features

- Analog input and output video connections for use with Composite video and Component Video signals, including conversion to HDMI Video output.
- HDMI switching for digital video signals up to 1080p, and HDMI Bypass video. Compatible with DVI components with HDMI-DVI adapter. For more information see the section 'HDMI: Frequently Asked Questions' in this manual.
- Videophile line-doubling and scaling up to high-definition resolutions.
- Accepts any type of video input: NTSC 480i, PAL 576i, NTSC 480p, PAL 576p, 720p, 1080i, 1080p, 1080p 24Hz and 1080p 3D.
- Outputs digital or analog video at any resolution (NTSC 480i, PAL 576i, NTSC 480p, PAL 576p, 720p, 1080i, 1080p, 1080p 3D) to match any digital or analog TVs.

Audio Features

- Rotel's Balanced Design Concept combines advanced circuit board layout, comprehensive parts evaluation, and extensive listening tests for superior sound and reliability.
- Analog bypass mode for pure 2-speaker stereo with no digital processing.
- Optical digital, coax digital, and analog input and output audio connections. (HDMI video connections also carry digital audio, so when using HDMI there is no need for separate audio cables.)
- DVD-A high-resolution multichannel audio signals are automatically detected.
- MULTI Input for 7.1 channel analog signals from DVD-A and SACD players. Subwoofer options include .1 channel pass through or bass redirect feature with an analog low-pass filter for a summed subwoofer output from seven channels.
- AM/FM tuner with 30 station presets, direct access tuning, and auto-tuning.
- RDS (Radio Data Systems) and RDBS (Radio Broadcast Data Service) capability.

Surround Features

- Automatic Dolby® Digital decoding for Dolby® Digital 2.0, Dolby® Digital 5.1, Dolby® Digital Surround EX™, Dolby® TrueHD and Dolby® Digital Plus recordings.
- Dolby® Pro Logic® IIx and Dolby® Pro Logic® IIz decoding (for 6.1 and 7.1 channel systems) with improved separation and frequency

response for Dolby® Surround matrix encoded recordings. Can be optimized for Music or Cinema sources, Pro Logic® or Games.

- Automatic decoding for DTS® 5.1 channel, DTS-ES® Matrix 6.1 channel, DTS-ES® Discrete 6.1 channel, DTS 96/24, DTS-ES® 96/24 digital, DTS-HD™ Master Audio and DTS-HD™ High Resolution recordings
- DTS® Neo:6® Surround modes for deriving surround channels for 5.1, 6.1 or 7.1 channel systems from 2-channel stereo or matrix surround recordings. Can be optimized for Music or Cinema sources.
- Rotel XS (eXtra Surround) automatically ensures proper decoding and optimum performance from any multichannel digital signal on 6.1 and 7.1 channel systems. Always active in any system with center back speaker(s), Rotel XS even works with signals that would not otherwise activate the proper decoding (such as non-flagged DTS-ES and Dolby Surround EX discs) or for which there is no extended surround decoder (such as DTS 5.1, Dolby Digital 5.1, and even Dolby Pro Logic II decoded Dolby Digital 2.0 recordings.)
- Surround modes for playback of surround sound material on 2 channel and 3 channel systems for total compatibility.
- Four DSP Music modes.
- Audio Return Channel (ARC) allows the Rotel system to act as your TV's loudspeakers.
- Seven built-in amplifier channels, each delivering 100 watts (all channels driven.)

Other features

- Zone 2,3, and 4 outputs with independent input selection and volume adjustments for multi-zone custom installations along with IR-repeater capability for operation from the remote zone.
- User friendly ON-SCREEN DISPLAY (OSD) menu system with programmable labels for all inputs. Choices of languages.
- Upgradable microprocessor software to accommodate future upgrades.
- Assignable 12V trigger outputs for remote turn-on of power amplifiers and other components.

Unpacking

Remove the unit carefully from its packing. Find the remote control and other accessories. Save the box as it will protect the product if you move or need to return it for maintenance.

Placement

Place the unit on a solid, level surface away from sunlight, heat moisture, or vibration. Make sure that the shelf can support the weight of the unit.

Place the unit close to the other components in your system and, if possible, on its own shelf. This will make initial hookup, and subsequent system changes easier.

The unit can generate heat during normal operation. Do not block ventilation openings. Allow a minimum of 10 cm or 4 inches of unobstructed space around the unit. If installed in a cabinet, make sure that there is adequate ventilation.

Do not stack other components or objects on top of the unit. Do not let any liquid fall into the cabinet.

Overview of Connections

Although the rear panel may look daunting, connecting the unit to your system is straightforward. Each of the source components in the system are connected to the unit's inputs with a pair of standard RCA cables for analog audio, a video connection (Composite, Component Video, and/or HDMI), and an optional digital audio cable (coax or optical)

Note: Surround formats like Dolby Digital and DTS are digital formats and the unit can only decode them when a digital input signal is available. For this reason, you should always connect your Blu-ray or DVD player's digital outputs to the unit, using either the HDMI, optical or coax inputs.

The outputs of the RSX-1562 receiver can be sent up to 7 speakers or sent to power amplifier(s) with standard RCA cables from the preamp audio outputs. The video signal from the RSX-1562 is sent to the TV monitor using the HDMI connections.

In addition, the receiver has MULTI input connections for use with a source component that does its own surround decoding, remote IR sensor inputs, and 12V trigger connections for remote turn-on of other Rotel components.

Note: Do NOT plug any system component into an AC source until all connections have been properly made. Video cables should have a 75 ohm impedance. The S/PDIF digital audio interface standard also specifies a 75 ohm impedance and all good digital cables adhere to this requirement. Do NOT substitute conventional audio interconnect cables for digital or video signals. Standard audio interconnects will pass these signals, but their limited bandwidth reduce performance.

When making signal connections, connect LEFT channels to LEFT channel jacks and RIGHT channels to RIGHT channel jacks. All RCA-type connections on this product follow these standard color codes:

Left channel audio: white RCA jack

Right channel audio: red RCA jack

Composite video: yellow RCA jack

Note: Each source input must be properly configured using the INPUT SETUP menu of the OSD menu system. We recommend going to this menu after connecting each source to configure it as desired. See Input Setup in the Setup section for information.

Video Inputs and Outputs

These connections are used for connecting video signals to and from the unit. See the Making Connections section for specific instructions for each type of component.

The unit provides Composite, Component Video, and HDMI connections. Composite video connections simplify system configuration; however, Component Video connections typically provide better picture quality and are required for HDTV or progressive scanned DVD video. For the best Video quality, use the HDMI connections for Blu Ray sources when possible.

Note: For proper operation, all HDMI components and TVs connected to the unit should be compatible with the HDMI Version 1.1 standard or higher. The HDMI digital connections are usually compatible with DVI components with an appropriate DVI-D cable adapter. For more information, see the section HDMI:Frequently Asked Questions, in this manual.

This Rotel receiver provides upscaling and downscaling for the various analog video formats. Composite Video or Component Video signals can be scaled to 480p/576p, 720p, 1080i and 1080p by choosing the appropriate output setting in the VIDEO/HDMI menu.

Note: The HDTV Component Video output is subject to HDCP copy protection. It may not display 720p or 1080i resolution when the source signal incorporates copy protection.

HDMI IN 1–6 Video Inputs ^[29]

HDMI inputs provide various digital video connections for use with components that have either HDMI outputs or DVI-D outputs (with an appropriate DVI-HDMI adapter). HDMI connections carry video signals in all formats including 3D signals up to 1080p/24Hz. The implementation of HDMI supports audio signals, or a separate audio connection from an HDMI component.

Six inputs, labeled HDMI VIDEO IN 1–6, accept signals from source components.

COMPOSITE IN 1–2 Video Inputs ^[23]

Two inputs accept standard composite video signals from source components using standard 75 ohm RCA video cables.

COMPOSITE Video Output ^[23]

The RCA jack, labeled COMPOSITE OUT, provide connections for sending composite video signals for recording on a VCR or other recording device.

Note: The unit cannot convert Component Video or HDMI signals to composite video signals at the record output. Therefore, only signals received at the composite video inputs are available at this output.

COMPONENT VIDEO 1–2 Video Inputs ^[24]

Component Video connections split the video into three signals – luminance (Y) and separate chrominance (PB and PR) signals, allowing delivery of a reference-quality picture with high definition signals. Component Video connections should be used for progressive scan DVD players and high-definition digital television receivers. Each of these signals is carried by a separate 75 ohm video cable with RCA connectors.

Two sets of inputs, labeled COMPONENT VIDEO IN 1–2, accept Component video signals from source components.

COMPONENT Video output ^[22]

The RCA jacks, labeled COMPONENT OUT, provide connections for sending analog video signals for recording on a VCR or other recording device.

RSP1572 Video INPUT vs. OUTPUT

		Compo site out	S-Video out	Component output						plugged HDMI output					
				480i/576i	480p/576p	720p	1080i	1080p/24	1080p	480i/576i	480p/576p	720p	1080i	1080p/24	1080p
Composite	480i/576i	■									○	○	○		○
Component	480i/576i			■							○	○	○		○
	480p/576p				■						○	○	○		○
	720p (60/50)					■					○	○	○		○
	1080i (60/50)						■				○	○	○		○
	1080p24							■						○	
	1080p (60/50)								■		○	○	○		○
HDMI	480i/576i									■					
	480p/576p										■				
	720p (60/50)											■			
	1080i (60/50)												■		
	1080p24													■	
	1080p (60/50)														■
		Compo site out	S-Video out	Component output						unplugged HDMI output					
				480i/576i	480p/576p	720p	1080i	1080p/24	1080p	480i/576i	480p/576p	720p	1080i	1080p/24	1080p
Composite	480i/576i	■													
Component	480i/576i			■											
	480p/576p				■										
	720p (60/50)					■									
	1080i (60/50)						■								
	1080p24							■							
	1080p (60/50)								■						
HDMI	480i/576i														
	480p/576p														
	720p (60/50)														
	1080i (60/50)														
	1080p24														
	1080p (60/50)														

- input video support : 480i,576i,480p,576p,720p60,720p50,1080i60,1080i50,1080p60,1080p50

- output video : 60Hz video input --> 60Hz video output

50Hz video input --> 50Hz video output

■ : bypass only output

○ : scaler output

High Definition TV Monitor Outputs 34

Two HDMI outputs of the unit send the High Definition video signals to your TV monitor. The HDMI outputs can send all enhanced or high definition video signals to a high-definition TV 2D (480p/576p, 720p, 1080i, or 1080p) and 3D (up to 1080p/24Hz).

The output resolution is specified in the VIDEO/HDMI setup menu. Analog video signals (Composite and Component) in any resolution can be converted to the desired resolution, except 3D and 1080p 24Hz signals at the HDMI outputs.

Note: HDMI Video signals are passed through without scaling.

Note: If the TV can not show the currently set HDMI resolution, press "2CH" and "MUTE" keys together on the front panel to change the resolution to 480p/576p.

HDMI Monitor Outputs 34

There are two HDMI Outputs which send out HDMI signals in parallel. The same signal is sent to both outputs at the same time. Only HDMI output 1 is ARC enabled. Connect your ARC enabled TV's HDMI input to this output.

Note: Your TV will most likely have more than one HDMI inputs. Not all of them will be ARC enabled. Please use the ARC enabled HDMI input of your TV. It should be labeled ARC next to the input.

Additional information for high definition outputs:

- Typically, choose the HDMI outputs with digital high-definition TVs such as LCD, plasma, or DLP monitors. Use the Component Video connections with analog high definition TVs such as CRT-based direct view or projection monitors.
- HDTV Component Video output is subject to HDCP copy protection. It may not display 720p, 1080i or 1080p resolution when the source signal incorporates copy protection. However, when Video Out is set to 480p/576p in the VIDEO/HDMI menu, all sources will be available.
- The video signal sent to the TV through the HDMI connection will not be displayed properly unless all HDMI components in the system, including the TV monitor, are compatible with the HDCP copy protection standard.
- Only audio signals passed-through directly from the source component are sent to the TV set through the HDMI connection. To send decoded audio from the RSX-1562 to the TV, you must select 'TV mode' in the VIDEO/HDMI menu.
- TV monitors with DVI-D connections can usually be connected to the HDMI output of the receiver with the use of an appropriate 24-pin DVI-HDMI adaptor. However, there are occasionally some incompatibilities with older DVI-D equipped monitors.
- Use the scaler setting of the RSX-1562's Analog Video Output to match the resolution of your TV.
- 3D Video is only available through the HDMI outputs.

Audio Inputs and Outputs

This Rotel receiver provides both analog and digital audio connections.

VIDEO 1–6 Audio Inputs 39

Six pairs of RCA inputs (VIDEO IN 1–6) provide connections for Left/Right analog audio signals from six additional source components. These inputs have corresponding video inputs and are used for VCRs, satellite TV tuners, DVD players, etc. However, they may also be used for additional audio only components, simply by omitting the corresponding video connections.

VIDEO Out Audio Output 40

One pair of RCA jacks (VIDEO OUT) provide connections for sending line level left and right analog audio signals for recording to a VCR.

This connection can be assigned to any analog audio connection.

CD Inputs 38

A Left/Right pair of RCA analog audio inputs for connecting a CD player.

MULTI Inputs 41

A set of RCA inputs accept up to 7.1 channels of analog signals from a DVD-A or SACD player. There are inputs for FRONT L & R, CENTER, SUB, REAR L & R, and CENTER BACK 1 & 2 or FRONT VERTICAL HEIGHT L & R in a Dolby PLIIz setup.

These inputs bypass all digital processing in the receiver and are routed directly to the Volume control and preamp outputs.

There are two subwoofer options for the MULTI input. Normally, the .1 channel input is passed through directly to the subwoofer output. An optional bass redirect feature duplicates the seven main channels, sums them, and sends this mono signal through a 100Hz analog low filter to the subwoofer output. This provides an unaltered analog bypass for the seven main channels along with a subwoofer signal derived from those channels.

Preamp Outputs 42

A group of ten RCA analog audio outputs sends the RSX-1562's line level output signals to external amplifiers and powered subwoofers. These outputs are variable level, adjusted by the RSX-1562's volume control. The ten connectors provide output for: FRONT L & R, CENTER 1 & 2, SURROUND (REAR) L & R, CENTER BACK CB1 & CB2 (or FRONT VERTICAL HEIGHT L & R), and SUBWOOFER 1 & 2.

Note: Depending on your system configuration, you may use some or all of these connections. For example, if you only have one center channel, connect it to the CENTER 1 output. If you only have one center back channel, connect it to the CB1 output.

Digital Inputs 25

The RSX-1562 accepts digital inputs from source components such as CD players, satellite TV tuners, and DVD players. The built-in digital receiver senses the correct sampling rates.

Note: With a digital input connection, the receiver will be used to decode the signal, rather than the source component's internal decoders. You must use digital connections for a DVD player that supplies a Dolby

Digital or DTS signal; otherwise the receiver will not be able to decode these formats.

There are seven digital inputs on the rear panel, three coaxial and four optical, as well as the HDMI Audio input that is carried by the HDMI cables along with the digital video signals. These digital inputs can be assigned to any of the input sources using the INPUT SETUP screen during the setup process. For example, you can assign the COAXIAL 1 digital input connector to the VIDEO 1 source and the OPTICAL 2 digital input to the VIDEO 3 source. By default, the source input buttons are factory configured to select the following inputs:

CD:	Digital Optical 1
Tuner:	Analog
Video 1:	HDMI Audio (HDMI 1)
Video 2:	HDMI Audio (HDMI 2)
Video 3:	HDMI Audio (HDMI 3)
Video 4:	HDMI Audio (HDMI 4)
Video 5:	Digital Coaxial 1
Video 6:	Digital Optical 2

Note: When using digital connections, you may also want to make the analog audio input connections described previously. The analog connection is necessary to send an analog Video and Audio signal to Zones 2, 3 & 4.

Digital Outputs 26

The RSX-1562 has two digital audio outputs (one coaxial and one optical) to send the digital signal from any of the digital inputs to a digital recorder or outboard digital receiver. When a digital input source signal is selected for listening, that signal is automatically sent to both digital outputs for recording.

USB Audio Connection 1

Music storage devices can be accessed by the unit through this input. Music storage devices such as MP3 players, iPod, iPhone, USB memory sticks or any other form of memory devices with USB interface can be connected to the unit through the front USB socket. The unit will automatically search music files from the connected storage device.

Note: When connecting iPod or iPhone to the front USB, the controls on the iPod/iPhone remain active. Only simple controls such as PLAY, STOP, SKIP TRACK can be controlled by the RSX-1562.

The front USB can also accept a USB Bluetooth dongle (supplied). This allows you to stream music from your Bluetooth device, i.e. mobile phone. Insert the USB Bluetooth dongle into the front USB, the display will show "READY" status. From your device (mobile phone etc..) activate Bluetooth and allow it to search for other Bluetooth devices and it will find "Rotel Bluetooth". Select "Rotel Bluetooth" and it will ask you to enter a password. Enter "0000" and accept. The RSX-1562 will recognize a device is attempting to connect to it, and will display this information on the OSD. Press ENT key on the remote to accept. The "READY" status will change to "RUNNING" and you can start streaming music to the RSX-1562.

Note: Not all Bluetooth dongles will operate with the unit. Please use the dongle supplied by Rotel.

Other Connections

AC Input 44

Your Rotel receiver is configured at the factory for the proper AC line voltage in the country where you purchased it (USA: 120 volts/60Hz AC or CE: 230 volts/50 Hz AC). The AC line configuration is noted on a decal on the back of your unit. Plug the supplied cord into the AC INPUT receptacle on the back of the unit.

Note: Memorized settings and video labels are preserved indefinitely, even if the unit is disconnected from AC power.

Master Power Switch 35

The large rocker switch on the rear panel is a master power switch. When it is in the OFF position, power to the unit is completely off. When it is in the ON position, the front panel STANDBY and remote control ON/OFF buttons can be used to activate the unit or put it into standby mode.

12V TRIGGER Connections 28

Many Rotel amplifiers offer the option of turning them on and off using a 12 volt trigger. These six connections provide this 12 volt trigger signal from the receiver. When the unit is activated, a 12 volt DC signal is sent from these jacks to the amplifiers to turn them on. When the receiver is put in STANDBY mode, the trigger signal is interrupted and the amplifiers turn off.

To use the remote turn on feature, connect one of the RSX-1562's 12V TRIG OUT jacks to the 12 volt trigger input of a Rotel amplifier, using a cable with mono 3.5mm mini-plugs on both ends. The +12 V DC signal appears at the "tip" connector.

Note: The 12V Trigger outputs are configured to turn on in various combinations only when specific input sources are activated. See the INPUT SETUP and ZONE 2-4 SETUP menus in the Setup section of this manual for details

REM IN Jacks 32

Four 3.5 mm mini-jacks (labeled EXT, ZONE 2, ZONE 3, and ZONE 4) receive command codes from a third-party infrared receiver or Rotel remote zone keypad. These remote IR inputs are used when the IR signals from a hand held remote control cannot reach the front panel IR sensor.

EXT: The EXT jack is used with an outboard IR receiver to duplicate the front panel IR sensor. This feature is useful when the unit is installed in a cabinet and the front panel sensor is blocked or when IR signals need to be relayed to other components.

ZONE: The ZONE 2, 3, or 4 jacks are used with IR repeater systems to receive signals from IR control systems in remote locations. For example, remote control signals sent to the ZONE 2 jack control the ZONE 2 features of the RSX-1562 and can be relayed to other components.

Consult your authorized Rotel dealer for information on external receivers and the proper wiring of 3.5mm mini-plugs to fit the REM IN jacks.

Note: The IR signals from the REM IN EXT and REM IN ZONE 2-4 jacks can be relayed to source components using external IR emitters or hard-wired connections from the IR OUT jacks. See the following section for additional information.

IR OUT Jacks 31

The IR OUT 1 & 2 jacks send IR signals received at the REM IN ZONE 2–4 jacks or the REM IN EXT jack to an infrared blaster or emitter placed in front of a source component's IR sensor. In addition, the IR OUT can be hard-wired to Rotel CD players, DVD players, or tuners with a compatible connector.

These outputs are used to allow IR signals from the three remote zones to be sent to the source components, or to pass along IR signals from a remote in the main room when the sensors on the source components are blocked by installation in a cabinet.

See your authorized Rotel dealer for information on IR emitters and repeater systems.

Rear Mini USB Socket 33 Remote IR OUT 30

The Rear USB connector and Remote IR OUT sockets are not used. These connectors are for future upgrades.

Computer I/O 27

This Rotel unit can be operated from a computer with audio system control software from third-party developers. This control is accomplished by sending operating codes from the computer via a hard-wired RS-232 serial connection. In addition, the RSX-1562 can be updated using special software from Rotel.

The COMPUTER I/O input provides the necessary network connections on the rear panel. It accepts standard RJ-45 8-pin modular plugs, such as those commonly used in 10-BaseT UTP Ethernet cabling.

For additional information on the connections, cabling, software, and operating codes for computer control or updating of the unit, contact your authorized Rotel dealer.

MAKING CONNECTIONS

Connecting Speakers 43

See Figure 3

This Rotel receiver has built-in amplifiers to power up to seven speakers in a 5.1, 6.1, or 7.1 channel surround audio system: normally, left/right front speakers, center channel speaker, left/right surround (rear) speakers, plus one or two center back speakers. There are seven pairs of binding post connections (one pair for each speaker) which accept bare wire, spade lugs, or banana plug connectors (in some markets)

Note: Speakers should have an impedance of 4 ohms or higher.

Each pair of connectors is color-coded for polarity: red for positive and black for negative. All speakers and all speaker wire is also marked for polarity. For proper performance, you must maintain this polarity at all speaker connections. Always connect the positive terminal of each speaker to the corresponding red speaker terminal on the receiver and the negative speaker terminal to the corresponding black connector on the receiver.

The connectors are labeled LEFT FRONT/ZONE, RIGHT FRONT/ZONE, LEFT SURROUND, RIGHT SURROUND, CENTER, CENTER BACK/VERTICAL HEIGHT/ZONE/FRONT 1/LEFT, and CENTER BACK/VERTICAL HEIGHT/ZONE/FRONT 2/RIGHT.

Route the wires from the receiver to the speakers. Leave enough slack so you can move the components to allow access to the speaker connectors. If you are using banana plugs, connect them to the wires and then plug into the back of the binding posts. The collars of the binding posts should be screwed in all the way (clockwise). If you are using terminal lugs, connect them to the wires. If you are attaching bare wires directly to the binding posts, separate the wire conductors and strip back the insulation from the end of each conductor. Be careful not to cut into the wire strands. Unscrew the binding post collars. Place the connector lug or the twisted bare wire around the binding post shaft. Turn the collars clockwise to clamp the connector lug or wire firmly in place.

1. Connect the front left speaker to the binding posts labeled LEFT "FRONT/ZONE".
2. Connect the front right speaker to the binding posts labeled RIGHT "FRONT/ZONE".
3. Connect the center channel speaker to the binding posts labeled "CENTER".
4. Connect the surround left speaker to the binding posts labeled LEFT "SURROUND".
5. Connect the surround right speaker to the binding posts labeled RIGHT "SURROUND".
6. Connect the center back left speaker (or vertical height left speaker) to the binding posts labeled "CENTER BACK/VERTICAL HEIGHT/ZONE/FRONT" 1/LEFT.

7. Connect the center back right speaker (or vertical height right speaker) to the binding posts labeled "CENTER BACK/VERTICAL HEIGHT/ZONE/Front" 2/RIGHT.

Note: Be sure that no loose wire strands can touch adjacent wires or connectors. After you have connected the speakers, you need to configure the receiver for the size and style of speakers in your system and calibrate the relative volume levels of the speakers using the built-in test tones. See the Setup section of this manual.

Redirect Feature

This Rotel receiver has a "redirect" feature that allows you to use the Front left and Front right or the Center Back amplifier channels to power remote Zone speakers, or use the Center Back channels for bi-amping the Front speakers in the main room.

For example, you might use a separate Rotel stereo power amplifier to drive the front speakers and then redirect the unused amplifier channels in the receiver to power two speakers in a remote location.

If your system does not have center back speakers, you can redirect the built-in Center Back channel amplifiers to drive a pair of speaker in Zone 2, 3 or 4. Alternatively, if you wish to bi-amp the front speakers in the main room, you can redirect the Center Back channels to "Front" to provide the necessary two additional front power channels.

This feature is configured using the Default Setup menu in the On-Screen Display system. See the Setup section in this manual.

Note: If you wish to use REDIRECT, you must make this selection before making any other speaker setup decisions, as the system will be reset to the factory defaults. Any setup programming carried out prior to selecting the REDIRECT will be lost. See Default Setup in the Setup section of this manual.

Connecting a Subwoofer 42

See Figure 3

To hook up a powered subwoofer, connect a standard RCA audio cable from either of the two PREOUT jacks labeled SUB to the input on the subwoofer's power amp. Both SUB outputs provide the same signal. Use either connection for a single subwoofer. Use both connections to hook up two subwoofers.

After you have connected the subwoofer, you need to configure the unit to use the subwoofer and calibrate the relative volume level of the subwoofer using the built-in test tones. See the Setup section of this manual.

Amplifiers 42

To hook up optional power amplifiers, connect an audio cable from each PREOUT jack to the input of the amplifier channel that will power the corresponding speaker. In a full home theater system, you will need to make as many as seven different connections in addition to the subwoofer. These connections are labeled FRONT L&R, CENTER, and REAR L&R. There are two CENTER jacks, use either jack for a single center channel or both if you have two center channels. In six or seven channel systems, you will make one or two additional connections for center back speaker(s). These jacks are labeled CB1/LVH and CB2/RVH, for either center back channels or vertical height channels.

AM Antenna 21

See Figure 10

The receiver includes a plastic loop antenna to receive AM radio signals. Remove this antenna from the box and locate it near the receiver. It can be tacked to a wall, using the mounting tab provided. Alternatively, you can fold the center portion of the antenna to form a tabletop stand.

Connect the 300 ohm twin-conductor wire from the loop antenna to the push terminals, labeled AM LOOP, attaching one wire to each terminal. It does not matter which wire attaches to which terminal, but make sure that the connections are solid and that the two wires do not touch.

You may need to rotate or otherwise reorient the antenna to find the best position.

Note: To use an outdoor antenna, connect its 300 ohm twin-conductor wire to the terminals in place of the loop antenna.

FM Antenna 20

See Figure 10

The receiver is supplied with a T-shaped indoor FM antenna. Connect the coax F-type plug to the FM antenna connector of the receiver. For best reception, unfold the T-shaped antenna. Eyelets at both ends of the T allow tacking the antenna to a wall, if desired. Experiment with positioning for best reception.

Connecting Monitor

----HDTV Monitor/Video Recording

See Figure 4

A key feature of this Rotel receiver is that it can send a video signal to any HDTV monitor in exactly the format that best matches the native mode and resolution of the TV.

Digital HDTVs, such as LCD, LED and Plasma flat-screens, display digital signals directly. These TVs should be connected to the receiver using the HDMI digital outputs.

The component outputs of the RSX-1562 can be connected to an analog HDTV display, but no OSD menu will be available.

HDMI digital connection: Connect one end of an HDMI cable to the HDMI OUT connector on the back of the receiver. Connect the other end of the cable to the HDMI input connector on the back of the HDTV.

You can usually connect the HDMI output of the receiver to a monitor with DVI-D inputs by using an appropriate HDMI-DVI adapter.

Note: In order for HDMI signals to be displayed properly, the TV monitor must be compatible with HDCP copy protection.

Connecting DVD, Blu-ray Player and Cable, Satellite, HDTV tuner

See Figure 5

DVD or Blu-ray player and TV tuner connections can be made using HDMI, Component Video, or Composite video connections.

Note: You must use either HDMI or Component Video connections for a progressive scan or high definition player. You must make an analog audio connection if you want to send signals to Zone 2,3 & 4.

For HDMI connections: Connect an HDMI cable from the output of the Blu-ray player to one of the HDMI IN 1–6 inputs on the receiver.

For Component Video connections: Connect a set of three Component Video cables from the output of the DVD player to one of the COMPONENT VIDEO 1–2 inputs on the receiver. Make sure to connect the Y output to the Y input, the PB output to the PB input, and the PR output to the PR input.

For Composite Video connections: Connect an RCA-RCA video cable from the output of the DVD player to one of the COMPOSITE IN 1–2 inputs on the receiver.

Note: Use the INPUT SETUP screen to assign the video input you have used to the Blu-ray source.

Digital audio connection: Connect the digital output of the DVD player to any one of the DIGITAL IN OPTICAL 1–4 or DIGITAL IN COAXIAL 1–3 inputs on the receiver. An HDMI cable carries both digital video and digital audio signals; therefore, no separate digital audio connection needs to be made.

Note: Use the INPUT SETUP screen to assign the digital input to the same video input source used above.

Optional analog audio connection: If you want to record the audio signal from the DVD player, connect the left and right analog outputs from the DVD player to one pair of VIDEO IN 1–6 audio input jacks. Make sure that you connect the right channel to the **R** input jack and the left channel to the **L** input jack.

Connecting DVD-A or SACD Player

See Figure 6

In most cases, DVD-A, SACD, and other external multichannel receivers are connected to the receiver by sending decoded analog audio signals using RCA cables. A DVD-A player with HDMI outputs can send digital signals directly to the receiver for decoding.

Analog Connections: To hook up a DVD-A, an SACD player (or any external surround decoder) with analog connections, use audio RCA cables to connect the outputs of the player to the RCA jacks labeled MULTI INPUT, making sure that you observe proper channel consistency, i.e. connect the right front channel to the FRONT R input, etc.

Depending on your system configuration, make six connections (FRONT L & R, SURROUND L & R, CENTER, and SUBWOOFER), seven connections (adding a CENTER BACK connection), or eight connections (adding two CENTER BACK or Vertical Height connections).

The MULTI inputs are analog bypass inputs, passing signals directly through to the Volume Control and preamp outputs, bypassing all of the digital processing. The receiver provides an optional bass redirect feature that duplicates the seven main channels and passes them through

an analog 100 Hz low pass filter, creating a summed mono subwoofer output derived from the main channels. See the INPUT SETUP menu in the Setup section of this manual for details on bass redirect feature.

HDMI digital connection: If the DVD-A player has HDMI outputs, simply connect an HDMI cable to the output of the player to one of the HDMI 1–6 inputs on the receiver. This cable sends the video signal from the player along with a digital audio signal. The DVD-A multichannel decoding is handled by the receiver.

Connecting Video Recorder

See Figure 7

VCR connections can be made to any VIDEO inputs.

Composite connections: Connect an RCA video cable from the output of the VCR to the COMPOSITE IN 1 input. Connect an RCA video cable from the COMPOSITE OUT jack to the VCR inputs.

Audio Connections: Connect the left and right analog outputs from the VCR to the VIDEO IN 1 audio inputs. Connect the left and right VIDEO OUT audio outputs to the analog inputs on the VCR.

Optional Digital Audio: For a digital recording device, connect the digital output of the recorder to one of the OPTICAL IN or COAXIAL IN digital inputs on the receiver. Use the INPUT SETUP screen to assign that digital input to the VIDEO source (VIDEO 1, 2, or 3) used for the previous connections. If the recording device accepts a digital recording input, connect one of the OPTICAL OUT or COAXIAL OUT connections to the digital input of the recorder.

Connecting CD Player

See Figure 8

Connect the digital output of the CD player to any of the Optical or Coax digital inputs on the receiver. Use the INPUT SETUP menu to assign the digital input to the CD (the default is OPTICAL 1).

Optional: Connect the left and right analog outputs from the CD player to the AUDIO IN jacks labeled CD (left and right). This option uses the CD player's D/A converters; however, this may result in an extra A/D and D/A conversion step.

There are typically no video connections for a CD Player and no video input is assigned to the CD, as a default setting.

Connecting Audio Recorder

See Figure 9

Connect the left and right analog outputs from an audio tape deck to the VIDEO IN audio jacks (left and right).

Connect the Left/Right VIDEO OUT jacks to the inputs on the audio tape deck.

Optional: For a digital recording device, connect the digital output of the recorder to one of the OPTICAL IN or COAXIAL IN digital inputs on the receiver. Use the INPUT SETUP screen to assign that digital input to an audio source. If the recording device accepts a digital recording input,

connect one of the OPTICAL OUT or COAXIAL OUT connections to the digital input of the recorder.

No video connections are required for an audio recording device.

Connecting USB Audio/iPod/iPhone

See Figure 11

Connect the iPod/iPhone or MP3 player to the front USB socket. Select tracks to be played from the iPod/iPhone the Rotel receiver will decode the signal and play the music.

Zone Outputs (ZONE 2,3,4)

This Rotel receiver has connections for three independent remote zones.

For audio connections to a remote zone, connect the left and right ZONE 2,3, or 4 jacks to the left and right channels of a remote zone amplifier with an RCA audio cable.

For video connections to a remote zone, connect the ZONE 2,3, or 4 VIDEO OUT jacks to the input of a TV in the remote zone using a Composite Video cable.

For control of the unit from a remote zone: connect a remote zone IR repeater to the ZONE 2, ZONE 3, or ZONE 4 REM IN jack using a cable terminated with 3.5mm plugs.

Operating the RSX-1562

Considering its large number of features, settings and options, this Rotel RSX-1562 is remarkably easy to operate. The key to operating the unit is its system of On-Screen Displays (OSD) which guide you through various choices.

To guide you through the operation of the unit, this section of the manual starts with explaining the basic layout and function of the front panel and the remote control. Then, we explain the basic operations such as turning the unit on and off, adjust volume, selecting a source for listening, etc. Following that is a detailed explanation of surround sound modes and how to configure the unit for various types of recordings. Finally, there are instructions for additional features and zone operation. All of these are features that may be used in normal operation. The last section of the manual (Configuration) details options that may be selected during initial setup and configuration of the unit, many of which will be set once and left untouched.

Throughout this manual, numbers in square boxes refer to the main unit illustration at the front of this manual. Letters refer to the remote handset illustration. When both appear, the function is found on both the unit's front panel and on the remote. When only one appears, that function is found either only on the main unit, or only on the remote.

Front Panel Overview

The following is a brief overview of the controls and features on the front panel of the unit. Details concerning the use of these controls are provided in subsequent sections of this manual describing various tasks.

Front Panel Display 3

The FL Display on the front panel shows the source selected and type of audio mode the unit is in.

Remote Sensor 3

This sensor receives IR signals from the remote control. Do not block this sensor. The IR sensor is behind the front panel display.

Note: The remainder of the buttons and controls on the front panel are described in the Overview of Buttons and Controls section.

Remote Control Overview

The RSX-1562 is supplied with an easy to use remote control RR-CX94. The unit can be set to IR code 1 or IR code 2 in case the unit is conflicting with other Rotel remote codes. Push the TUN key and 1(2) at the same time sets the remote control into IR code 1(2). Point the remote to the RSX-1562 and press 1(2) for 5 seconds sets the RSX-1562 in IR code 1(2). The factory default is IR code 1.

The supplied remote can also be set to control zones 2,3 and 4 from the main room by setting the remote to IR codes 3, 4 or 5. Set to IR code 3, 4, or 5 by pressing TUN key and 3 (4 or 5) at the same time. IR code 3 is for Zone 2. IR code 4 is for Zone 3 and IR code 5 is for Zone 4 operation.

You can also set the CD codes for PLAY, STOP, FAST FORWARD, REV etc, from the factory default IR code 1 to 2, if you find the unit is interfering with other Rotel CD players in your system.

To change the CD code, point the remote at the unit and press "CD" and 2 (1) keys at the same time. Release the "CD" key and continue to press the 2 (1) key for more than 5 seconds until the unit changes the code.

Overview of Buttons and Controls

This section provides a basic overview of the buttons and controls on the front panel and the remote control. Detailed instructions on the use of these buttons are provided in the more complete operating instructions in the following sections.

STANDBY and Power ON/OFF Buttons

The front-panel STANDBY button and the remote control ON/OFF button activate or deactivate the unit. The rear panel master POWER switch must be in the ON position for the remote standby function to operate.

VOLUME Knob and VOLUME +/- Buttons

The VOLUME +/- buttons on the remote and the large rotary control on the front panel provide the master VOLUME control, adjusting the output level of all channels simultaneously.

DISPLAY (DISP) Button

Push this toggle button to display the current Audio and Video source, input mode and output mode. To change Dynamic Range, push the DISP button then push DOWN and Left/Right keys to adjust.

RCVR SETUP Button Navigating and Select (ENT) keys

The RCVR SETUP button pulls out the OSD on the TV. Use the navigation keys UP/DOWN/Left/Right and ENT to access the various menus.

Note: The MENU button on the remote control will not operate with the RSX-1562 without additional programming by your dealer.

MUTE Button

Push the MUTE button once to turn the sound off. An indication appears in the front panel and on-screen displays. Press the button again to restore previous volume levels.

INPUT Buttons

This button on the front panel can be used to change sources.

ZONE Button

This button serve as a standby button for the currently selected remote zone, toggling the zone on or off.

SEL Button

This button can be used to select the desired zone fro additional changes such as changing the input, adjusting the volume, or turning a remote zone on or off. Repeatedly press the button until the desired zone appears in the front panel: RECORD > ZONE 2 > ZONE 3 > ZONE 4. Once the desired zone appears, you have 10 seconds to make the desired change. Change the input selection by pressing an INPUT button. When ZONES 2-4 appear, you can also adjust the volume, or turn the zone on or off by pressing the ZONE button.

MODE buttons SUR+

The MODE buttons/SUR+ button serve to display surround mode information of current listing/viewing media, which can be set when selecting input source. On the remote, press SUR+ key, then use the Left/Right navigation keys to change the mode.

Other buttons on the remote and front panel can directly access specific modes.

2CH: change the audio mode to STEREO, DOWN MIX or BYPASS.

PLIIx MODE: change the Pro-Logic mode.



DSP: Changes the DSP decode mode (analog) from DSP1 - 4, 5/7 CH Stereo.

PLCM: toggles the audio mode to Pro Logic Cinema or Music.

Playback buttons

These buttons provide basic control functions for iPod/USB AUDIO playback.

PLAY  button: Start playing the selected media

STOP  button: Stop current playing track, press  button to resume
Push STOP key for 5 seconds to safely remove the USB device from the front socket.

PAUSE  button: Temporarily suspend play

PREVIOUS  button: One push -Skip to start of current track
Two pushes Skip to previous track.

NEXT  button: Skip to next track.

RND Button

This button can be used for the front USB connection and put the music played in random/shuffle mode.

P-EQ Button/Knobs

Used to display the EQ Frequency level and GAIN. Also can be used for temporary adjustments of EQ. Push P-EQ button and use the UP/Down keys to adjust GAIN value. Use the Left/Right keys to skip to the next frequency. From the front panel, push the FREQ knob to bring up the EQ value. Turn the knob to change the frequency. Turn the parametric EQ knob to adjust the GAIN value.

For permanent EQ and GAIN adjustments, please enter the value in the EQ setup menu.

SPKR Button

This button can access the various speaker setting and adjust the output level for each speaker in the system. Use the navigations keys to change values. This is only a temporary change. To make permanent adjustments, please access the TEST TONE setting from the OSD.

MEM Button

For setting up tuner presets into memory, see Tuner Control section.

Party Mode: Selecting the Same input for all outputs

You may wish to have the same input for listening, recording and all of the remote zones. The RSX-1562 makes this configuration easy, (called party mode) by linking inputs for recording and remote zones.

To activate Party Mode, Press and hold ZONE button on the front panel for 3 seconds. The words PARTY ON appear briefly in the display and the ZONE icon flashes for 10 seconds. The record input selection and all remote zones input selections will be displayed as SOURCE, indicating that they are linked to the input selected for listening. While in party mode, a "P" indicator remains in the front panel display.

To cancel Party mode, press and hold the SEL button on the front panel or remote for at least 3 seconds.

SURROUND SOUND

To get the best performance from your unit, it helps to understand the many surround sound formats available today, to know which decoding process to use for a particular recording, and how to select it. This section provides basic background information about surround sound formats. The following sections provide detailed operating instructions for automatic and manual selection of surround modes.

Overview of Surround Format

Dolby Surround & Dolby Pro Logic II

The most widely available surround sound format for consumer audio/video is Dolby Surround®, available on nearly all commercial VHS tapes, many television broadcasts, and most DVDs. Dolby Surround is the consumer version of the analog Dolby Stereo system first introduced in the film industry in 1972. It is a matrix-encoding system that records front left, front center, front right, and a mono surround channel into a 2-channel stereo recording. During playback, a Dolby Pro Logic® or Pro Logic II decoder extracts each channel and distributes it to the appropriate speakers.

The original Dolby Pro Logic decoder delivered a mono signal with reduced high-frequency content to the surround speakers. A more advanced decoder in the receiver, Dolby Pro Logic II, increases the separation and frequency response of the surround channels for significantly improved performance with Dolby Surround encoded recordings.

Dolby Pro Logic II decoding should be used for any analog recording labeled "Dolby Surround" or any Dolby Digital 2.0 soundtrack. Dolby Pro Logic II does a superb job deriving surround sound from conventional 2-channel stereo recordings, using phase relationships to extract front, right, center, and surround channels. A "music mode" makes Pro Logic II an excellent choice for audio CDs.

Dolby Digital

In 1992, a digital recording system, called Dolby Digital, was first used in the film industry. Dolby Digital is a recording/playback system that uses compression techniques to store large amounts of audio data efficiently, much like the JPEG format stores large photographs in small files on a computer. Because it is capable of performance beyond that of audio CDs and can tailor its output for a wide ranges of system configurations, Dolby Digital is the standard audio format for DVDs and for digital television broadcasting in the United States.

The Dolby Digital system can be used to record up to six discrete audio channels, but can also be used for fewer. For example, a Dolby Digital 2.0 soundtrack is a digital 2-channel recording of a matrix encoded

Dolby Surround soundtrack. To play a Dolby Digital 2.0 recording, use Dolby Pro Logic II decoding as previously described.

The most common use of Dolby Digital in newer films, in both the film industry and in home theater, is Dolby Digital 5.1. Instead of encoding multiple surround channels on a two-channel recording, Dolby Digital 5.1 records six discrete channels: front left, front center, front right, surround left, surround right, and a Low Frequency Effects (LFE) channel containing ultra-low bass signals intended for a subwoofer. A Dolby Digital decoder extracts the channels from the digital bitstream, converts them to analog signals and routes them to the appropriate amplifiers and speakers. All channels provide full frequency response with total separation between all channels and large dynamic range capability. A Dolby Digital 5.1 soundtrack can provide more impressive surround sound than matrix Dolby Surround.

Decoding of Dolby Digital 5.1 soundtracks is automatic. When the RSX-1562 detects a Dolby 5.1 signal on one of its digital inputs, it activates the proper processing. Keep in mind that Dolby Digital is only available from digital sources (a DVD, a LaserDisc, or a Digital TV/Cable/SAT tuner). Also, you must connect the source with a digital cable (coax or optical) to an active digital input on the receiver .

Note: Many DVDs have a Dolby Digital 2.0 matrix soundtrack as the default, which should be decoded with Pro Logic II. The Dolby Digital 5.1 soundtrack may have to be selected as an option from the setup menus at the beginning of the DVD. Look for a Dolby Digital 5.1 selection under "Audio" or "Languages" or "Setup Options" when you insert the disc.

DTS 5.1 & DTS 96/24

DTS® (Digital Theater Systems) is an alternative digital format competing with Dolby Digital in both movie theaters and home theater markets. The basic functions of the DTS system are similar to those of Dolby Digital (for example, 5.1 discrete channels), however the technical details of the compression and decoding processes differ somewhat and a DTS decoder is required.

A recent extension of the DTS encoding system is DTS 96/24 and the 6.1-channel version DTS-ES 96/24. These recordings provide the performance of a 96kHz sampling rate while still using the actual 48kHz sampling rate of standard DTS discs.

Like Dolby Digital, DTS can only be used on a digital recording and, therefore, is only available for home use on LaserDiscs, DVDs, or other digital formats. To use the RSX-1562's DTS decoder, you must connect your DVD player to the unit's digital inputs. As with Dolby Digital 5.1, detection and proper decoding of DTS 5.1 signals is automatic.

Note: DVDs with a DTS soundtrack almost always have it configured as an option to the standard matrix Dolby Surround format. To use DTS, you may have to go to the setup menus at the beginning of the DVD and select "DTS 5.1" instead of "Dolby Surround" or "Dolby Digital 5.1". In addition, many DVD players have the DTS digital bitstream turned off by default and cannot output a DTS soundtrack (even if selected on the disc's menu) until you activate the player's DTS output. If you hear no sound the first time you attempt to play a DTS disc, go to the DVD player's configuration menus and turn on the DTS bitstream. This is a one-time setting and need only be done once.

DTS Neo:6

This Rotel receiver features a second type of DTS surround sound decoding: DTS Neo:6. This decoding system is similar to Dolby Pro Logic II and is designed for playback of any 2-channel stereo recording, either matrix-encoded or not. The Neo:6 decoder can be used with any conventional 2-channel source such as a stereo TV or FM broadcast or a CD. It can also be used as an alternative method of decoding matrix-encoded Dolby Surround recordings or TV broadcasts. Activate the DTS Neo:6 decoding with the PLLx MODE button on the front panel or with the SUR+ key on the remote as detailed later in this section. DTS Neo:6 is not used with DTS 5.1 digital sources and the button need not be pressed for those recordings.

Dolby Digital Surround EX DTS-ES 6.1 and 7.1 Channel Surround

In 1999, the first Dolby Digital soundtrack was released to theaters with an additional center back surround channel, intended to increase the directional effects from behind the audience. This additional surround channel is encoded into the two existing surround channels in Dolby Digital 5.1, using a matrix encoding process similar to that used previously in Dolby Surround. This new extended surround capability is called Dolby Digital Surround EX.

DTS has added a similar capability for recording this extended surround information called DTS-ES® 6.1 Matrix. They have also taken it one step further and developed the capability to record this extended surround information as a discrete channel in a system called DTS-ES® 6.1 Discrete.

All of these systems are extensions of the existing Dolby Digital 5.1 and DTS 5.1 digital surround sound formats. Users with one center back speaker (a 6.1 configuration) or two center back speakers (a 7.1 configuration) can take advantage of this extended surround information. On traditional 5.1 channel systems, Dolby Digital Surround EX or DTS-ES 6.1 discs sound exactly the same as 5.1 channel discs in each respective format.

If you have configured your system with one or two center back speakers, decoding of DTS-ES discs is automatic, just as it is with standard DTS soundtracks. Likewise, decoding of Dolby Digital Surround EX discs is automatic with one exception. Some Surround EX titles do not have the detection "flag" encoded on the disc. To activate the Dolby Digital Surround EX features for these discs (or for standard 5.1 channel Dolby Digital discs), you must manually activate Dolby Surround EX processing.

Dolby Pro Logic IIx 6.1 and 7.1 Channel Surround

This technology from Dolby uses advanced matrix decoding for the surround channels in a 6.1 channel or 7.1 channel system. Working with any 2.0 channel or 5.1 channel recording, Dolby Pro Logic IIx processing distributes the surround channel information among three or four surround channels, with a Music mode optimized for musical recordings and a Cinema mode optimized for film soundtracks.

Dolby Pro Logic IIz 7.1 Height Surround

The latest technology from Dolby delivers enhanced effects through the addition of front height speakers. These added channels create a lifelike soundstage. It identifies and decodes the spatial cues that occur naturally in all content whether stereo, 5.1, music CD 5.1 and 7.1

channel sources then process ambient sound effects such as wind or rain fall and direct them to the front height speakers.

Rotel XS 6.1 and 7.1 Channel Surround

This RSX-1562 also features Rotel XS (eXtended Surround) processing provides extended surround performance on 6.1 and 7.1 channel systems. The key benefit of Rotel XS is that it works at all times with all multichannel digital signals, even those that might not otherwise activate Dolby Digital EX or DTS-ES surround decoding for the center back channel(s). Always available when center back speaker(s) are configured in the system setup, Rotel XS decodes the surround channels and distributes the extended surround channels to the center back speaker(s) in a way that tends to create a diffuse surround effect. Rotel XS works with matrix-encoded surround signals (such as non-flagged DTS-ES and Dolby Surround EX discs) as well as digital source material that is not Dolby Surround EX encoded (such as DTS 5.1, Dolby Digital 5.1, and even Dolby Pro Logic II decoded Dolby Digital 2.0 recordings).

Dolby Digital Plus

Built on Dolby Digital, the multichannel audio encoding standard for DVD and HD broadcasts, Dolby Digital Plus was designed for the new high-resolution delivery formats, but remains compatible with current A/V receivers. It is supported by the HDMI digital connection standard. Dolby Digital Plus can provide up to 7.1 channels with discrete channel output at higher bit rates than Dolby Digital. Dolby Digital Plus is an optional sound format for Blu-ray, and a mandatory inclusion for HD DVD discs.

Dolby True HD

Dolby TrueHD is based on lossless coding technology to deliver studio master-quality sound. Dolby TrueHD supports up to eight full-range channels (the maximum allowed by Blu-Ray) of 24-bit/192 kHz audio. Dolby TrueHD is supported by the HDMI v1.3 digital connection.

Additional features include Dialogue Normalization, which maintains the same volume level when changing to other Dolby Digital and Dolby TrueHD programming, and Dynamic Range Control (or 'Night Mode'), reducing peak volume levels to allow late-night viewing of high-energy surround sound without disturbing others. Dolby TrueHD is an optional sound format for Blu-ray Disc, and a mandatory format for HD DVD.

DTS-HD Master Audio & DTS-HD High Resolution Audio

Like Dolby's TrueHD, DTS-HD Master Audio is an advanced lossless audio codec which is an optional sound format for Blu-ray discs, again delivering the original recorded sound 'bit-for-bit'. It is also an optional format for HD-DVD disc recordings. DTS-HD Master Audio is compatible with the HDMI v1.3 connection standard, and supports a maximum of 192kHz sampling at 24-bit audio in 5.1 CH mode, and 24bit/96KHz resolution for eight channels in multichannel mode. A DTS-HD capable receiver can also decode discs recorded with DTS-HD High Resolution Audio. This format is not lossless but delivers virtually all of the original recording, though not literally identical to the studio master.

DSP Music Modes

Unlike all of the formats mentioned above, the RSX-1562 offers four surround modes that are not part of a specific recording/playback system. These modes (DSP 1-4) use digital signal processing that adds special acoustic effects to any signal. DSP processing can be used with Dolby Surround recordings, Dolby Digital recordings, CDs, radio broadcasts, or

any other source material; however, typically DSP settings would be used with source material for which there is no specific surround decoder .

The four DSP MODES in the receiver use digital delay and reverberation effects to simulate progressively larger acoustic environments with DSP 1 being the smallest type of venue (such as a jazz club) and DSP 4 being a large venue (such as a stadium). Typically used to add ambience and a sense of space when listening to music sources or other sources that lack surround sound encoding.

2CH/5CH/7CH stereo formats

The RSX-1562 also provides four modes that disable all surround processing and deliver stereo signals to amplifiers and speakers. The four options are:

2CH Stereo: Turns off the center channel and all surround channels in the system and delivers a conventional 2-channel signal to the front speakers. If the system is configured to route bass signals from the front speakers to the subwoofer , this capability remains in effect.

Analog Bypass: For 2-channel analog inputs, there is a special stereo mode that bypasses ALL of the RSX-1562's digital processing. The two front speakers receive pure analog stereo full-range signals with no subwoofer crossover, no delay, no level adjustments, and no parametric eq.

5CH Stereo: Distributes a stereo signal to 5.1 channel systems. The left channel signal is sent, unchanged, to the front left and surround left speakers. The right channel is sent to the front right and surround right speakers. A mono sum of the two channels is sent to the center channel speaker.

7CH Stereo: This mode is the same as 5CH Stereo described above except that it also distributes stereo signals to center back speaker(s) installed in the system.

Other Digital Formats

Several other digital formats are not surround sound formats at all, but rather systems for digital 2-channel recordings.

PCM 2-channel: This is an uncompressed 2-channel digital signal that is used for standard CD recordings and some DVD recordings, particularly of older films.

DTS Music 5.1 Discs: These discs are a variation of audio CDs that include a DTS 5.1 channel recording. The receiver decodes these disc s just like a DTS movie soundtrack when played on a CD player or DVD player with a digital output connection.

DVD-A music discs: Taking advantage of the increased storage capacity of the DVD disc, new high bit rate multichannel audio recordings are available on DVD-A discs. DVD-A discs may include multiple versions of the recording including standard PCM stereo, Dolby Digital 5.1, DTS 5.1, and 96kHz/24 bit (or higher) multi-channel recordings using MLP compression. Several of these formats (standard PCM, Dolby Digital, and DTS 5.1) can be decoded by the receiver when the DVD player is connected with a digital cable. However, the existing optical and coax digital audio connection standard does not provide sufficient bandwidth for multichannel high sampling rate MLP recordings. Therefore, you must use the HDMI high-definition digital connection to replay the high-resolution audio soundtrack of DVD-A discs. Alternatively, the high-resolution audio

can be decoded by the DVD-A player and the resulting analog signals sent to the receiver' s MULTI INPUT.

SACD®: This is a proprietary high-resolution audio standard for use on SACD compatible disc players. As with DVD-A discs, the bandwidth is too high for today's digital connection. Thus, these discs must be decoded by a SACD compatible player, with the output sent to the receiver's MULTI INPUTS.

MP3: MP3 format recordings, often downloaded from the Internet, can be played on portable MP3 players or some disc players that can read CD-ROM discs. These players can be connected to the receiver' s digital inputs, but must output a digital PCM stream.

Automatic Surround Modes

Decoding of digital sources connected to the digital inputs is generally automatic, with detection triggered by a “flag” embedded in the digital recording telling the receiver what decoding format is required. For example, when Dolby Digital 5.1 or DTS 5.1 channel surround is detected, the receiver activates the proper decoding.

The unit will detect DTS-ES Matrix 6.1 or DTS-ES Discrete 6.1 discs and activate DTS-ES® Extended Surround decoding. Dolby Digital Surround EX recordings also trigger automatic decoding (although not all Surround EX DVDs have the necessary flag and may require manually activating Surround EX decoding).

The unit will also detect Dolby True HD and DTS-HD Master Audio automatically.

Likewise, a digital input from a standard compact disc, a DTS 96/24 disc, or DTS-ES 96/24 disc, will be auto-detected and properly decoded to 2CH stereo operation.

Dolby Pro Logic IIx/IIz or Rotel XS processing can be configured to be automatically active in all 6.1 or 7.1 channel systems configured with center back speaker(s) and will ensure proper extended surround decoding of all multichannel digital signals, even those that might not otherwise trigger the proper extended surround mode.

In many cases, the receiver will also recognize a digital signal with Dolby Surround encoding (such as the default soundtrack on many DVDs) and activate Dolby® Pro Logic II® decoding. Additionally, you can configure a default surround mode for each input using the INPUT SETUP menu (see the Setup section of this manual).

Combined with the auto-detection of Dolby Digital 5.1 and DTS, this default surround setting makes operation of the receiver’s surround modes totally automatic. For example, if you set Dolby Pro Logic II movie mode as the default for all of your video inputs, the receiver will automatically decode Dolby Digital 5.1 and DTS soundtracks when they are played and use Pro Logic II matrix decoding for all other recordings.

For stereo inputs such as CD and Tuner , you could select STEREO mode as the default for 2-channel playback or Dolby Pro Logic II music mode if you prefer to hear music sources in surround sound.

Note: A digital signal coming into the receiver will be recognized and properly decoded. However, on a DVD with multiple soundtracks, you must tell the DVD player which one to send to the receiver. For example, you may need to use the DVD’s menu system to select the Dolby Digital 5.1 or DTS 5.1 soundtrack rather than the default Dolby Digital 2.0 Dolby Surround soundtrack.

Manually Selecting Surround Modes

As described in the previous section, the combination of auto-detection of Dolby Digital and DTS recordings and setting default surround modes for each input during the setup of the receiver makes operation of surround modes totally automatic. For many users, this automatic surround mode selection will meet all of their listening needs.

For users who prefer a more active role in setting surround modes, buttons on the remote and the front panel provide manual selection of surround mode that are not automatically detected or, in some cases, to override an automatic setting.

Manual settings available from the front panel and/or the remote might be used when you want to play:

- Standard 2-channel stereo (Left/Right speakers only) with no surround processing.
- Down mixed 2-channel playback of Dolby Digital 5.1 or DTS recordings.
- Dolby 3-channel stereo (Left/Right/center) of 2-channel recordings.
- 5-channel or 7-channel stereo from 2-channel recordings.
- One of four DSP modes for DSP concert hall simulation from 2-channel music recordings.
- Dolby Pro Logic II cinema or music mode matrix decoding of 2-channel recordings.
- DTS Neo:6 cinema or music mode matrix decoding of 2-channel recordings.
- Dolby Digital Surround EX decoding of Dolby Digital 5.1 channel recordings or Dolby Digital Surround EX discs that do not trigger automatic decoding.

Note: DTS, DTS-ES Matrix 6.1, DTS-ES Discrete 6.1, DTS 96/24, DTS-ES 96/24, DTS-HD, Dolby Digital and Dolby TrueHD signals are auto-detected and cannot be overridden. However, you can choose to use Dolby Digital Surround EX decoding for any Dolby Digital 5.1 source material. You can also down mix Dolby Digital 5.1 or DTS 5.1 recordings for 2-channel playback.

- PCM 2-channel (non 96kHz) digital signals can be overridden to Dolby Pro Logic II, Dolby 3-Stereo, DTS Neo:6, DSP 1–4, 5CH Stereo, 7CH Stereo, and Stereo.
- Dolby Digital 2-channel Stereo can be overridden to Dolby Pro Logic II, Dolby 3-Stereo, and Stereo.

The following topics describe in detail the manual surround mode options available for each type of recording:

Dolby Digital/TrueHD discs Dolby Digital Surround EX discs

Dolby Digital decoding is auto-detected and cannot be overridden. You may, however, select a 2-channel down mix of 5.1 channel recordings. In a 6.1 or 7.1 channel system, you can also choose Dolby Surround EX, Dolby Pro Logic IIx Music, Dolby Pro Logic IIx Cinema (7.1 channel only), or Rotel XS processing for center back channels.

Note: In addition to the options that follow, you can press the 2CH button on the remote to toggle between 2-channel down mix and multichannel playback.

- **On a 5.1 system.** Press the SUR+ button on the remote, then press the Left/Right buttons to change between DD 5.1 channel or DD 2.0 channel down mix playback.
- **On a 6.1 system.** Press the SUR+ button on the remote, then use the Left/Right buttons to step through five options: DD 2.0 channel down mix, DD 5.1 channel, DD Surround EX center back processing, DD with Pro Logic IIx Music center back processing or DD with Rotel XS center back processing. You should typically select Surround EX or discs that are labeled Dolby Digital Surround EX. For standard 5.1 channel discs, Dolby Pro Logic IIx Music or Rotel XS processing will provide a more diffuse surround effect than the more highly localized Dolby EX decoding and will probably be the better 6.1 channel options for non-Surround EX discs. Selecting DD 5.1 forces the center back channel processing off for conventional 5.1 channel playback.
- **On a 7.1 system.** Press the SUR+ button on the remote, then use the Left/Right buttons to step through six options: DD 2.0 channel down mix, DD 5.1 channel, DD Surround EX center back processing, DD with Pro Logic IIx Music center back processing, DD with Pro Logic IIx Cinema back channel processing, or DD with Rotel XS center back processing. You should typically select Surround EX or discs that are labeled Dolby Digital Surround EX. For standard 5.1 channel discs, Dolby Pro Logic IIx Music or Rotel XS processing will provide a more diffused surround effect than the more highly localized Dolby EX decoding and may be the better 7.1 channel options for non-Surround EX discs. Selecting DD 5.1 forces the center back channel processing off for conventional 5.1 channel playback.

Note: When playing any Dolby Digital source, you can select one of three dynamic range control settings. For Dynamic Range adjustments please refer to Overview of Buttons and Controls section of this manual, under DISPLAY (DISP) Button. In the case of Dolby TrueHD source, there is an AUTO mode.

Dolby Digital 2.0 discs

Dolby Digital decoding is auto-detected and cannot be overridden. You may, however, select 2-channel playback, 5.1 channel playback with Pro Logic II matrix surround, 6.1/7.1 channel playback with Pro Logic IIx/IIz matrix surround, or Dolby 3-Stereo playback.

- **On a 5.1 system.** Press the SUR+ button on the remote, then use the Left/Right buttons to step through four options: DD 2.0 channel, DD with Pro Logic II Cinema matrix surround, DD with Pro Logic II Music matrix surround, or Dolby Digital 3 channel stereo. You can also repeatedly press the 2CH button on the remote or front panel to select the same options.
- **On a 6.1/7.1 system.** Press the SUR+ button on the remote, then use the Left/Right buttons to step through four options: DD 2.0 channel, DD with Pro Logic IIx Cinema matrix surround, DD with Pro Logic IIx Music matrix surround, Pro Logic IIz (7.1 ch only), or Dolby Digital 3 channel stereo. You can also repeatedly press the 2CH button on the remote or front panel to select the same options.
- **To select Cinema or Music options in Pro Logic II or Pro Logic IIx modes.** Press the SUR+ button twice while in Pro Logic II or Pro Logic IIx modes. Then, use the Left/Right buttons to select the Music or Cinema options.

Note: When playing any Dolby Digital source, you can select one of three dynamic range control settings. For Dynamic Range adjustments please refer to Overview of Buttons and Controls section of this manual, under DISPLAY (DISP) Button.

DTS/DTS-HD 5.1 discs DTS 96/24 discs DTS-ES 6.1 discs

DTS decoding is auto-detected and cannot be overridden. You may, however, select a 2-channel down mix of 5.1 channel recordings or add Rotel XS center back processing for 5.1 channel discs.

Note: In addition to the options that follow, you can press the 2CH button on the remote or front panel to toggle between 2-channel down mix and multichannel playback.

- **On a 5.1 system.** Press the SUR+ button on the remote, then press the Left/Right buttons to change between DTS 5.1 channel or DTS 2.0 channel down mix playback.
- **On a 6.1/7.1 system with a DTS/DTS-HD 5.1 disc.** Press the SUR+ button on the remote, then use the Left/Right buttons to step through the optional modes: DTS 2.0 channel down mix, DTS 5.1 channel, DTS with Rotel XS center back processing, DTS with Pro Logic IIx Music center back processing, DTS with Pro Logic IIx Cinema center back processing (available only for 7.1 channel systems). Selecting DTS 5.1 forces the center back channel processing off for conventional 5.1 channel playback.
- **On a 6.1/7.1 system with a DTS-ES disc.** Press the SUR+ button on the remote, then use the Left/Right buttons to step through three optional modes: DTS 2.0 channel down mix, DTS 5.1, or DTS-ES 6.1ch/7.1ch playback.
- **On a 6.1/7.1 system with a DTS 96/24 disc.** Press the SUR+ button on the remote, then use the Left/Right buttons to step

through the optional modes: DTS 2.0 channel down mix, DTS 96, or DTS 96 with Rotel XS center back processing.

Digital Stereo discs

This group of recordings includes any non-Dolby Digital 2-channel signal from the receiver's digital inputs. You can play these recordings in 2-CH Stereo, Dolby 3-Stereo, 5-CH Stereo, 7-CH Stereo modes. You can also use Dolby Pro Logic II matrix surround (5.1 ch systems), Dolby Pro Logic IIx Music (6.1/7.1 ch systems), Dolby Pro Logic IIx Cinema (6.1/7.1 ch systems), Dolby Pro Logic IIz (7.1 CH system), DTS Neo:6 surround, or one of the DSP 1-4 modes.

All of the bass management settings (speaker size, subwoofer, and crossover) are in effect with digital stereo inputs.

Note: In addition to the options that follow, you can select 2-channel, Pro Logic II Cinema (for 5.1 ch systems), Pro Logic II Music (for 5.1 ch systems), Pro Logic IIx Music (for 6.1/7.1 ch systems), Pro Logic IIx Cinema (for 6.1/7.1 ch systems), Dolby Pro Logic IIz (7.1 ch system) by pressing one of the surround mode buttons on the remote (2CH, PLC, PLM).

- **To select any mode for 2-channel digital recordings.** Press the SUR+ button on the remote, then use the Left/Right buttons to step through the optional modes until the desired mode is displayed.
- **To select STEREO mode for 2-channel digital recordings.** Press the 2CH button on the remote. To select Dolby multichannel modes for 2-channel digital recordings. You can also step through the Dolby options (Pro Logic I, Pro Logic IIx/IIz, or 3-Stereo) by repeatedly pressing the PLIIx MODE button on the front panel. You can select Pro Logic or Pro Logic IIx Cinema or Music modes by pressing the PLPCM button on the remote.

To change the Cinema or Music option in Pro Logic II mode, press the SUR+ button on the remote twice while in Pro Logic II or Pro Logic IIx modes. Then, press the Left/Right buttons to select the option.

- **To select DTS Neo:6 mode for 2-channel digital recordings.** You can also step through the DTS options (Neo:6 Cinema or Neo:6 Music) by repeatedly pressing the DSP button on the front panel.

To change the Cinema or Music option in Neo:6 mode, press the SUR+ button on the remote twice while in Neo:6 mode. Then, press the Left/Right buttons to select the option.

- **To select DSP multichannel modes for 2-channel digital recordings.** You can also step through the DSP options (MUSIC 1-4, 5CH, 7CH) by repeatedly pressing the DSP button on the front panel.

Analog Stereo

This type of recording includes any conventional stereo signal from the receiver's analog inputs, including analog audio from CD players, FM tuners, VCRs, tape decks, etc.

Analog stereo inputs require a choice about how the signal is routed through the receiver. One option is the analog bypass mode. In this mode, the stereo signal is routed directly to the volume control and the outputs. It is pure 2-channel stereo, bypassing all of the digital circuitry. None of the bass management features, speaker level settings, EQ settings,

or delay settings are active. There is no subwoofer output. A full-range signal is sent directly to two speakers.

The other option converts the analog inputs to digital signals, passing them through the digital receivers in the RSX-1562. This option allows all of the features to be active including bass management settings, crossovers, subwoofer outputs, EQ settings, etc. In this mode, you can select several surround modes including 2-CH Stereo, Dolby 3-Stereo, 5-CH Stereo, 7-CH Stereo modes. You can also use Dolby Pro Logic II or Pro Logic IIx surround, DTS Neo:6 surround, or one of the DSP 1-4 modes.

- **To select Stereo or Analog bypass mode for 2-channel analog recordings.** Press the 2CH button on the remote or front panel to toggle between Stereo (with digital processing) or Analog Bypass (no digital processing) modes.
- **To select any mode for 2-channel analog recordings.** Press the SUR+ button on the remote, then use the Left/Right buttons to step through the optional modes until the desired mode is displayed.
- **To select Dolby multichannel modes for 2-channel analog recordings.** You can also step through the Dolby options (Pro Logic II, Pro Logic IIx, or 3-Stereo) by pressing the PLIIx MODE button on the front panel. You can select Pro Logic or Pro Logic IIx Cinema or Music modes by pressing the PLPCM button on the remote.

To change the Cinema or Music option in Pro Logic II mode, press the SUR+ button on the remote twice while in Pro Logic II or Pro Logic IIx modes. Then, press the Left/Right buttons to select the option.

- **To select DTS Neo:6 modes for 2-channel analog recordings.** You can also step through the DTS options (Neo:6 Cinema or Neo:6 Music) by repeatedly pressing the PLIIx MODE button on the front panel.

To change the Cinema or Music option in Neo:6 mode, press the SUR+ button on the remote twice while in Neo:6 mode. Then, press the Left/Right buttons to select the option.

- **To select DSP multichannel modes for 2-channel analog recordings.** You can also step through the DSP options (DSP 1-4, 5CH, 7CH) by repeatedly pressing the DSP button on the front panel.

BASIC OPERATIONS



This section covers the basic operating controls of the RSX-1562 and the remote.

Selecting Inputs

You can select any of source inputs for listening and/or watching: USB/iPod player, CD, TUNER, VIDEO 1, VIDEO 2, VIDEO 3, VIDEO 4, VIDEO 5, VIDEO 6 or MULTI INPUT.

All of the source inputs (except for USB/iPod) can be customized using the ON-SCREEN DISPLAY configuration menus to accept either analog signals or digital signals from one of the seven assignable digital inputs, or HDMI Audio. When a digital input is assigned, the unit checks for the presence of a digital signal at that input. If a digital signal is present when the source is selected, it is automatically activated and the proper surround mode enabled. If no digital signal is present, the analog inputs for that source are selected. This auto-sensing is the preferred configuration for digital source inputs such as DVD players. When an ANALOG input is assigned, the unit will not access a digital signal, even though one may be available at the digital input.

When you have configured the source input, you can use INPUT buttons to select the various inputs.

1, **Press the INPUT buttons on the front panel**   , it will switch to the selected source input i.e. CD, Tuner, Video 1 etc...

2, **Press the source input button on the remote.** These factory configured source input buttons select following inputs by default:

CD: Digital Optical 1

Tuner: Analog

Video 1: HDMI Audio (HDMI 1)

Video 2: HDMI Audio (HDMI 2)

Video 3: HDMI Audio (HDMI 3)

Video 4: HDMI Audio (HDMI 4)

Video 5: Digital Coaxial 1

Video 6: Digital Optical 2

Each source input can be configured using the ON-SCREEN DISPLAY menu system for use with the proper input type (analog or digital auto-sensing). See the INPUT MENU section for configuration instructions.

Note: In addition to selecting analog or digital signals, the configuration options also permit custom labeling and selection of a default surround mode for each of the eight inputs.

Remote Zone Operation

The RSX-1562 provides multi-zone capability, allowing you to enjoy movies and music and operate the system from a second, third, and fourth room. From the remote location, you can select a source component (independent from the source playing in the main room), and operate the source components.

To use the remote monitor capability, you need additional components: a pair of speakers installed in the remote zone, an amplifier to driver them, and optional TV monitor for video signals and a third party IR repeater system.

Zone 2, 3, or 4 can be controlled from the main room using the RSX-1562's front panel or remote control SEL button. Operation from the remote zone requires installation of an infrared repeater (from Rotel or other suppliers) which relays infrared remote control commands from remote zone to the ZONE 2 - 4 REM IN connectors on the back of the unit.

Several points about the remote ZONE function:

- There are two options for the remote zone output level, selectable from the ZONE SETUP configuration menu. VARIABLE output provides full adjustment of the volume level. FIXED output disables the remote zone volume control with the output permanently set to a specified level. This might be useful for sending a line level signal to a preamp or integrated amp with its own volume control or to a distribution amplifier with multiple volume controls.
- The remote control supplied with the RSX-1562 will operate the remote zones if used with a repeater system from the remote zone. It can also be programmed to operate Rotel or other brand's components via its IR OUT jack..
- Any source component connected to the unit's composite video and/or analog audio inputs can be sent to the remote zone outputs. The remote zones operate independently of the main room. You can select a different source or adjust remote zone volume without affecting the MAIN outputs in any way.
- Avoid sending the same infrared command to the RSX-1562's front panel sensor and to a remote zone repeater at the same time. This means that remote zones must be in a different room from the RSX-1562.

Remote Zone Power On/Off

Once master power is applied to the unit by pressing the rear panel POWER switch button, the unit provides independent power on/off operation for the remote zones. Pressing the remote control ON/OFF buttons in the main room activates or deactivates the unit in the main room only and has no effect on the remote zones. Conversely, activating or deactivating Zone 2, 3, or 4 has no effect on the main listening room. However, placing the rear panel master POWER switch in the OFF position completely shuts off the unit, for all zones.

Note: For proper power on and off operation with remote zones, the RSX-1562's power mode should be set to the factory default STANDBY setting or to the DIRECT setting using the OTHER OPTIONS menu described in the Setup section of this manual.

Controlling Zones 2- 4 from the Main Room

You can control Zones 2 - 4 from the main room using front panel or remote control buttons to activate or deactivate Zones 2 - 4, change input sources, and adjust the volume. Controlling Zone 2, 3 or 4 from the main room is accomplished by pressing the SEL button on the front panel or remote two or more times, putting the RSX-1562 in Zone 2, 3 or 4 control mode temporarily. When Zone 2, 3 or 4 status is displayed, the OSD and/or front-panel displays show the current source selection and volume in that zone for ten seconds, during which time you can use the front panel VOLUME control and INPUT buttons to change the ZONE 2, 3 or 4 settings.

To turn Zone 2, 3 or 4 on or off:

1. Press the SEL button repeatedly until the desired zone status appears in the OSD and front panel displays.
2. Within 10 seconds, press the front panel ZONE button to toggle the selected Zone on or off.
3. Following 10 seconds with no commands, the unit reverts to normal operation.

To change the Zone 2, 3 or 4 input source:

1. Press the front panel SEL or remote repeatedly until the desired zone status appears in the OSD and front panel displays.
2. Within 10 seconds, press one of the INPUT buttons to select a new source for the selected zone. The name of the selected source appears in the display. Instead of pressing an INPUT button, you can also push the navigation buttons on the remote to step through the inputs.
3. Following 10 seconds with no commands, the unit reverts to normal operation.

To change Zone 2, 3 or 4 volume:

1. Press the front panel SEL or remote repeatedly until the desired zone status appears in the OSD and front panel displays.
2. Within 10 seconds, adjust the volume control on the front panel or remote to change the output level for the selected zone. The new setting appears in the display.
3. Following 10 seconds with no commands, the unit reverts to normal operation.

Controlling Zones 2 - 4 from Remote Locations

With a properly configured IR repeater system, you have full control of Zones 2-4 using the supplied remote control, from the zone locations. You can select and operate a source, adjust the volume, and turn the relevant Zone on or off. Whatever commands you send from the remote control will change ONLY the Zone for the location you are in, just as if you were controlling a totally independent audio system in that room. These changes will not affect the main listening room.

To turn the Zone on or off, press ON/OFF buttons on the remote. To adjust the volume in the Zone, press the VOLUME buttons on the remote. To select a different analog input source, press one of the INPUT buttons on the remote or front panel.

All OFF command: A long press of the OFF button (more than 3 seconds) from any room, sets all rooms to standby, i.e. the unit goes to standby completely.

Note: The volume adjustment is only available if the Zone 2 - 4 outputs are configured to use VARIABLE levels. With FIXED levels, the volume control for Zones 2 - 4 is disabled.

USB/iPod operation

USB Storage Device Connection 1

1. Plug your USB storage device containing music files, or through a USB adaptor into the front panel's USB socket.
2. Press USB button on the remote to enter iPod/USB mode. The unit will automatically search music file from the root directory. Once the directory is found, press PLAY and the unit will start playing. The display shows song's information, such as name, time, total tracks.:
3. If your music files are in sub directories, use ENT, Up/Down button on the remote to move to the directory, Left/Right button to return/enter the directory. Press ENT button to start playing.
4. Use the numeric keys on the remote to skip to a specific track number. Press PLAY to start playback.

iPod/iPhone Connection 1

1. Apple's iPod/iPhone can be connected via the iPod's USB cable to the USB front socket.
2. The iPod/iPhone will send a digital music signal to the unit. All operations can be made from the iPod/iPhone. Only simple commands can be made through the Rotel unit as explained below.
3. The iPod/iPhone screen will remain active while connected to the unit. If no operations are made from the iPod/iPhone for an extended period, the screen will turn to "charging".

PlayBack Control Buttons L

1. Use the PLAY ► button to start playback.
2. Use the STOP ■ button to stop playback.
3. Use the PLAY ►/PAUSE || button to either pause a currently playing track or to restart a currently paused track or to restart a stopped track.
4. Use the BACK TRACK buttons ◀◀ to start playback of the previous track in the list.
4. Use the FORWARD TRACK button ▶▶ to start playback of the next track in the list.
5. Push and hold the STOP ■ button for 5 seconds to safely remove the USB device from the unit.

USB Bluetooth

USB Bluetooth dongle connection

The front USB can also accept a USB Bluetooth dongle (supplied). This allows you to stream music from your Bluetooth device, i.e. mobile phone. Insert the USB Bluetooth dongle into the front USB, the display will show "READY" status. From your device (mobile phone etc..) activate Bluetooth and allow it to search for other Bluetooth devices. It will find "Rotel Bluetooth". Select "Rotel Bluetooth" and it may prompt you to enter a password. Enter "0000" and accept. The RSX-1562 will recognize that a device is attempting to connect to it, and will display this information on the OSD. Press ENT key on the remote to accept. The "READY" status will change to "RUNNING" and you can start streaming music to the RSX-1562.

Note: Not all Bluetooth dongles will operate with the unit. Please use the dongle supplied by Rotel.

Note: Not all Bluetooth devices will require a password. If requested for one enter "0000".

Note: Some Bluetooth devices may require you to establish connection again with the RSX-1562 if the unit was powered off. If this occurs, please go through the above steps to re-connect

SETUP

The Rotel RSX-1562 features two types of information displays to help operate the system. The first consists of simple status displays that appear on the TV screen whenever primary settings (Volume, Input, etc.) are changed. These status displays are self-explanatory.

A more comprehensive ON-SCREEN DISPLAY (OSD) menu system is available at any time by pressing the RCVR/SETUP button on the remote. These OSD menus guide you through the configuration and setup of the RSX-1562. In general, the settings made in the configuration process are memorized as default settings and need not be made again for normal operation of the unit.

The OSD menus can be configured to display several different languages. The default English version of all main menus are shown at the front of this manual. If your language is available, those menus will be shown in the instructions. If you would like to change from the default English language before proceeding, go to the instructions for the OTHER OPTIONS menu later in this manual. From this menu, you can change the language display.

Menu Basics

Navigation Buttons

The following remote control buttons are used to navigate the OSD menu system:

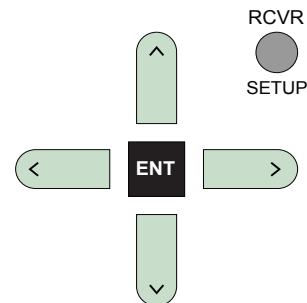

RCVR/SETUP button: Press to display the MAIN MENU. If a menu is already visible, push this button to cancel the display.

Up/Down Buttons: Press to move up and down in the lists of menu items that appear on the OSD screens.

Left/Right Buttons: Press to change the current settings for a selected menu item on OSD screens.

ENT Button: Press ENT to confirm a setting and return to the MAIN menu.

System Status

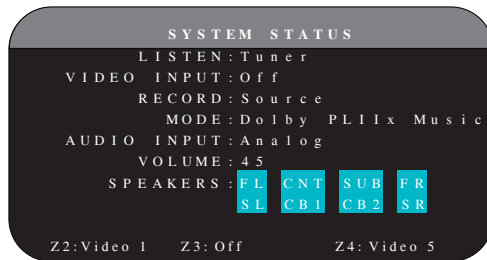

The SYSTEM STATUS menu provides a snapshot of the current system settings. This screen appears when you press enter the STATUS Menu.

LISTEN: the input source selected for listening.

VIDEO INPUT: the video source selected for viewing. It is necessary to assign a video input, by selecting from Composite 1–2, Component 1–2, HDMI 1–6 or OFF (no video) in the INPUT SETUP menu.

RECORD: the source selected for recording from the VIDEO and AUDIO outputs.

MODE: the current surround sound mode.

AUDIO INPUT: the input selected for the current source: Optical Digital, Coaxial Digital, HDMI Audio, Analog, etc.

VOLUME: the current volume setting.

SPEAKERS: highlights the speakers that are currently configured for the system (front right, center, subwoofer, front left, surround left, center back 1, center back 2, and surround right).

ZONE: shows the current status of ZONE 2, 3 & 4 (Z2, Z3 & Z4). In the example, the ZONE 2 source is Video 1, ZONE 3 is OFF, and the ZONE 4 source is Video 5.

No changes can be made using this screen; it only provides information. To go to the rest of the menus.

Note: While in STATUS menu, press ENT to return to MAIN Menu.

Main Menu



The MAIN MENU provides access to OSD screens for various configuration options. MAIN MENU is reached by pressing the RCVR/SETUP button on the remote. To go to the desired menu, move the highlight using the Up/Down and Left/Right buttons on the remote and press the ENT button. Press the RCVR/SETUP button again to cancel the display and return to normal operation.

Configuring Inputs

A key step in setting up the unit is to configure each source input using the INPUT SETUP screens. Configuring the inputs allows you to set defaults for a number of settings including the type of input connector, the desired surround mode, custom labels that appear in the displays when a source is selected, and many more. The following OSD menus are used to configure the inputs.

Input Setup

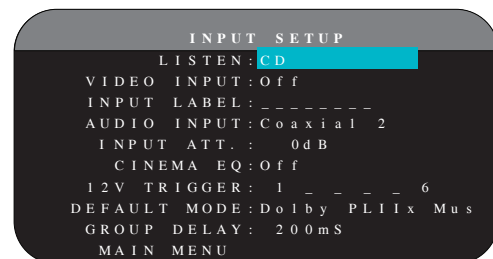

The INPUT SETUP menu configures the source inputs and is reached from the MAIN menu. The screen provides the following options, selected by placing the highlight on the desired line using the Up/Down buttons:

LISTEN: changes the current listening input source (CD, TUNER, VIDEO 1–6, iPod/USB, & MULTI INPUT). Changing this input also allows you to select a specific input for configuring.

VIDEO INPUT: selects the video source to be displayed on the TV monitor. Assign the input to a source component you have connected by selecting from Composite 1–2, Component 1–2 and HDMI 1–6. For audio only sources (such as a CD player), you would typically specify OFF so that no video is displayed.

INPUT LABEL: The eight character labels for all inputs can be customized. Place the highlight on this line to begin labelling. The first character in the label will be flashing.

1. Press the Left/Right buttons to change the first letter, scrolling through the list of available characters.

- Press the ENT button on the remote to confirm that letter and move to the next position.
- Repeat steps 1 and 2 until all eight characters (including blank spaces) have been completed. The final press of the ENT button saves the new label.

AUDIO INPUT: assigns a physical input connection to use as the default for the source displayed in the first line of the menu. Can be OPTICAL 1-4, COAXIAL 1-3, ANALOG or HDMI Audio.

Note: HDMI Audio input is assigned to a specific VIDEO input.

When a digital input is the default, the unit will check for a digital signal when the INPUT SOURCE is selected. If no digital signal is present, the unit will automatically revert to the analog input.

When an ANALOG input is the default, the unit will not access a digital signal, even though one may be present at the digital input; thus, the ANALOG setting forces the unit to use an analog signal. Assigning a digital input (with its auto-sensing) is generally the preferred configuration for any source with a digital output.

INPUT ATT: the audio INPUT ATT function allows you to reduce the level of the selected audio input from 0dB to -6dB, in 1dB steps. Use this attenuation for louder sources to match them to quieter sources.

Note: If a source connected to a digital input is selected, that signal will automatically be sent to both digital outputs for recording.

CINEMA EQ: The RSX-1562 includes a CINEMA EQ feature which reduces the high-frequency content of movie soundtracks to simulate the frequency response of a large movie theater and/or eliminate sibilance. You can turn the CINEMA EQ on or off as the default setting for the selected input using this menu choice. In general, this setting should be OFF for most source inputs, unless you are consistently bothered by excessively bright sound from movie soundtracks.

12V TRIGGER: The RSX-1562 has six 12V trigger outputs (labeled 1-6) that supply a 12V DC signal to turn on Rotel components and other components as needed. This menu item turns on specific 12V trigger outputs whenever the indicated source is selected. For example, set up the VIDEO 1 input to turn on the 12V trigger for your DVD player. Any combination of trigger outputs can be programmed for each source.

- Press the Left/Right buttons on the remote to change the first position from blank to 1 (activating TRIGGER 1 for that source).
- Press the ENT button on the remote to move to the next position.
- Repeat until all six positions are set as desired. A final press of the ENT button confirms the selection.

DEFAULT MODE: The DEFAULT MODE setting allows you to set a default surround sound mode for each source input. The default setting will be used unless the source material triggers automatic decoding of a particular type or unless the default setting is temporarily overridden by the front panel or remote surround mode buttons.

Note: Default surround modes are stored independently for the analog and digital inputs for each source.

Options for the default surround modes are: Dolby Pro Logic II, Dolby 3 Stereo, DSP 1, DSP 2, DSP 3, DSP 4, 5ch Stereo, 7ch Stereo, PCM 2 Channel, DTS Neo:6, Bypass (for analog input only), and Stereo.

Note: The following types of digital discs or source material are generally detected automatically and the proper decoding activated with no action or setting required: DTS, DTS-ES Matrix 6.1, DTS-ES Discrete 6.1, Dolby Digital, Dolby Digital Surround EX, Dolby Digital Plus, Dolby TrueHD, DTS-HD Master Audio, DTS-HD High Resolution Audio, Dolby Digital 2-channel, PCM 2-Channel, PCM 96kHz and MP3.

Since Dolby Digital 5.1 and DTS sources are detected and decoded automatically, the default setting typically tells the unit how to process a 2-channel stereo signal. For example, you might have your CD input default to 2-channel stereo, DVD and VCR inputs default to Dolby Pro Logic II processing for matrix-encoded Dolby surround material, and TUNER input default to one of the DSP modes.

In some cases, the default setting can be manually overridden by the front panel surround mode (2CH, PLIIx MODE, DSP) buttons or the SUR+ button on the remote. See the Manually Selecting Surround Modes section of this manual for more information on which settings can be overridden.

Two of the default surround mode settings available on this menu offer additional choices. Dolby Pro Logic II decoding offers a choice of CINEMA or MUSIC settings, etc. DTS Neo:6 decoding also offers a choice of CINEMA or MUSIC settings. When either Dolby Pro Logic II or DTS Neo:6 is selected with this menu item, the current setting choice will also be displayed. In addition, the function of the SEL button changes, taking you to a sub-menu where you can change the settings and/or additional parameters for Dolby Pro Logic II or DTS Neo:6 decoding. See the following section for details.

GROUP DELAY: Also known as "lip-sync" delay, this setting delays the audio signal for an input by the specified amount to match the video input. This feature can be useful when the video signal is delayed more than the audio signal as sometimes happens with upconverted digital TV receivers or when trying to match a radio broadcast with the video from a sports event.

The range of available settings is from 0ms to 500ms, in 5ms increments. The setting is individually stored for each input and is the default group delay each time that input is selected. The setting can be temporarily overridden from the front panel or the remote.

To return to the MAIN menu from the INPUT SETUP menu (except when Dolby Pro Logic II or DTS Neo:6 is selected in the SURR MODE field), press the ENT button. Press RCVR/SETUP button on the remote to cancel the menu display and return to normal operation.

Multi Input Setup



When the MULTI INPUT source is selected on the INPUT SETUP menu, the available options change to reflect the fact that these inputs are direct analog inputs and bypass the unit's digital processing. The INPUT, CINEMA EQ, DEFAULT MODE and GROUP DELAY options are not available since these are all digitally implemented features.

The VID INPUT, INPUT LABEL, INPUT ATT and 12V TRIGGER options are still available and work as described on the previous menu.

One additional option, LFE REDIRECT, provides an alternative bass management configuration. Typically, the eight channels of the MULTI INPUT are configured as pure analog bypass signals, going straight from the inputs to the volume control and the preamp outputs, bypassing all of the digital processing. There are no crossovers and no bass management; therefore, whatever signal goes into the subwoofer channel will be sent to the subwoofer preamp output.

This configuration may not be ideal for multi-channel systems configured with high-pass speakers, redirecting bass to a powered subwoofer. An option, called LFE REDIRECT, sends the seven main channels directly to the outputs as usual. In addition, it takes a duplicate copy of these seven channels, combines them into mono, and routes them through a 100Hz analog low-pass crossover to the subwoofer preamp output. This creates a summed mono subwoofer signal, derived from the seven main channels of the MULTI INPUT.

Use the LFE REDIRECT OFF setting for the pure analog bypass configuration. Use the LFE REDIRECT ON setting to derive the mono summed subwoofer output.

Dolby Pro Logic IIx

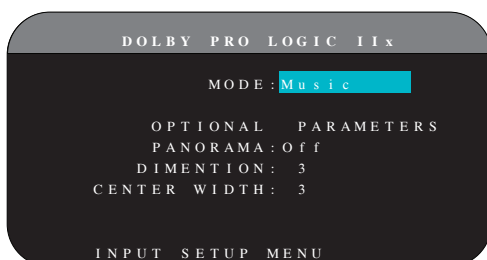

When Dolby Pro Logic IIx is selected as the default surround mode on the INPUT SETUP menu, there are additional settings and parameters to optimize the surround decoding for music or movie soundtracks. Dolby Pro Logic II uses matrix decoding algorithms to derive a center channel and surround channels from 2-channel source material.

The first line of the Dolby Pro Logic IIx sub-menu selects CINEMA, MUSIC, GAME, or PRO LOGIC modes for matrix decoding. Use the Left/Right buttons on the remote to select a mode.

Select **CINEMA** to optimize for Dolby Surround encoded movie soundtracks including increased surround separation and full-bandwidth surround channel frequency response.

Select **MUSIC** to optimize for musical recordings. When the MUSIC mode is selected, three additional parameters will be available on the OSD screen. Use the Up/Down buttons on the remote to select a parameter. Use the Left/Right buttons to change the selected parameter as follows:

- **PANORAMA:** The Panorama option extends the front stereo image to include the surround speakers for a dramatic "wraparound" effect. The options are OFF or ON.
- **DIMENSION:** The Dimension option allows you to gradually adjust the soundfield towards the front or towards the rear. There are seven incremental settings from 0 to 6. A setting of 0 shifts the soundfield towards the rear for maximum surround effect. A setting of 6 shifts the soundfield to the front for minimum surround effect. The default setting of 3 provides a "neutral" balance between the two extremes.
- **CENTER WIDTH:** The Center Width option allows you to spread the signal intended for the center speaker to the left and right front speakers, widening the perceived soundfield. There are eight incremental settings from 0 to 7. With the setting of 0, there is no center width spreading and all of the center channel information is sent to the center speaker. The maximum setting of 7 shifts all of the center channel signal to the left and right speakers, essentially muting the center speaker and maximizing the soundfield width. Other settings provide incremental steps between the two extremes. The factory default is set to 3.

Select **GAME** to optimize for Dolby Surround encoded video games.

Select **PRO LOGIC** for original Dolby Pro Logic decoding. Typically, Pro Logic II (Cinema or Music modes) will provide better surround performance, even with older source material. Original Pro Logic mode provides 5.1 channel surround sound, even on 6.1/7.1 channel systems.

When you have completed all the desired adjustments, highlight the INPUT SETUP MENU line at the bottom of the screen and press the ENT button to return to the INPUT SETUP menu.

DTS Neo:6



When DTS Neo:6 is selected as the default surround mode on the INPUT SETUP menu, there are additional option settings and parameters available to optimize the surround decoding for various types of recordings, music or movie soundtracks. DTS Neo:6 uses matrix decoding algorithms to derive a center channel and surround channels from 2-channel source material.

In DTS Neo:6 mode, there will only be one choice available on the sub-menu: selecting CINEMA or MUSIC modes. Use the Left/Right buttons on the remote to change the settings.

- Select **CINEMA** to optimize the DTS Neo:6 decoding for movie soundtracks.
- Select **MUSIC** to optimize the DTS Neo:6 decoding for musical recordings.

When you have completed the setting, highlight the INPUT SETUP MENU line at the bottom of the screen and press the ENT button to return to the INPUT SETUP menu.

Configuring Speakers and Audio

This section of the setup process covers items concerning audio reproduction such as the number of speakers, bass management including subwoofer crossovers, establishing equal output levels for all channels, delay settings, and parametric eq.

Understanding Speaker Configuration

Home theater systems vary in the number of speakers and the bass capabilities of those speakers. This receiver offers surround modes tailored to systems with various numbers of speakers and bass management features which send bass information to the speaker(s) best able to handle it – subwoofers and/or large speakers. For optimum performance, you must tell the receiver the number of speakers in your system and how bass should be distributed among them.

Note: There are two types of bass in a surround system. The first is bass recorded in each of the main channels (front, center, and surround). This bass is present in all recordings and soundtracks. In addition, Dolby Digital 5.1 and DTS 5.1 recordings may have a Low Frequency Effects (LFE) channel – the .1 channel. This LFE channel, typically played by a subwoofer, is used for effects such as explosions or rumble. The use of the LFE channel will vary from soundtrack to soundtrack. Recordings that are not encoded in Dolby Digital or DTS do not have the LFE channel.

The following configuration instructions refer to LARGE and SMALL speakers, referring more to their desired bass configuration than their physical size. Specifically, use the LARGE setting for speakers that you want to play deep bass signals. Use the SMALL designation for speakers that would benefit from having their bass sent to more capable speakers. The bass management system redirects bass information away from all SMALL speakers and sends it to the LARGE speakers and/or the SUBWOOFER. It may be useful to think of LARGE as “full-range” and SMALL as “high-pass filtered.”

- **Five LARGE speakers and subwoofer:** This system requires no bass redirection. All five speakers play the normal bass recorded in their respective channels. The subwoofer plays only the LFE channel bass. Depending on the soundtrack, there may be minimal use of the LFE channel, so the subwoofer would be under utilized. Meanwhile the normal bass places higher demands on the capabilities of the other speakers and the amplifiers driving them.
- **LARGE front, center, surround speakers, no subwoofer :** The normal bass from the front, center, and surround channels is played in its respective speakers. With no subwoofer, the LFE bass is redirected

to all five LARGE speakers. This places significant demands on these speakers and their amplifiers, as they must play their own normal bass plus the very demanding LFE bass.

- **All SMALL speakers and subwoofer:** The normal bass from all channels is redirected to the subwoofer, which also plays the LFE channel. The subwoofer handles ALL of the bass in the system. This configuration provides several benefits: deep bass is played by the speaker most suited to do so, the main speakers may play louder with less distortion, and the need for amplifier power is reduced. This configuration should be used with bookshelf-size or smaller main speakers. It should also be considered in some cases with floorstanding front speakers. This configuration is advantageous when driving the system with moderate power amplifiers.
- **LARGE front speakers, SMALL center and surround speakers, and a subwoofer:** The normal bass from the SMALL center and surround speakers is redirected to the LARGE front speakers and the subwoofer. The LARGE front speakers play their own normal bass plus the redirected bass from the SMALL speakers and LFE bass. The subwoofer plays the LFE bass plus the redirected bass from all of the other channels. This might be an appropriate configuration with a pair of very capable front speakers driven by a large power amplifier. A potential disadvantage with mixed LARGE and SMALL configurations is that the bass response may not be as consistent from channel to channel as it might be with the all SMALL configuration.

Note: As an alternative configuration with a satellite/subwoofer package as the front speakers, follow the speaker manufacturer’s instructions, connecting the high-level inputs of the powered subwoofer directly to the front speaker outputs of your amplifier and connecting the satellites to the subwoofer’s own crossover. In this arrangement, the speakers would be classified as LARGE and the subwoofer setting would be OFF for all surround modes. No information is lost during playback because the system redirects bass information to the front LARGE speakers. While this configuration ensures proper satellite speaker operation by using the speaker’s own crossovers, it has some disadvantages in terms of system calibration and would generally not be the preferred configuration.

Speaker Setup



The SPEAKER SETUP menu is used to configure the RSX-1562 for use with your specific loudspeakers and to determine the bass management configuration as described in the previous overview. The menu is accessed from the MAIN menu.

The following speaker options are available:

FRONT SPEAKERS (small/large): Use the LARGE setting to have the front speakers play low bass (full-range). Use the SMALL setting to redirect normal bass away from these speakers to a subwoofer (high-pass filtered).

CENTER SPEAKER(S) (large/small/none): Use the LARGE position (not available with SMALL front speakers) to have the center speaker play low bass (full-range). Use the SMALL position if your center channel speaker has limited low frequency capability, or if you prefer that the bass be sent to the subwoofer (high-pass). Select the NONE setting if your system does not have a center channel speaker (the surround modes will automatically divide all center channel information equally between the two front speakers, creating a phantom center channel).

SURROUND SPEAKERS (large/small/none): Select the LARGE setting (not available with SMALL front speakers) to have the surround speakers play low bass (full-range). If your rear speakers have limited bass capability or if you would prefer that the bass go to a subwoofer, use the SMALL setting (high-pass). If your system has no rear surround speakers, select the NONE setting (surround channels are added to the front speakers so none of the recording is lost).

CENTER BACK SPEAKER(S) (large1/large2/small1/small2/none): Some systems have one or two additional center back surround speakers. Select the LARGE settings (not available with SMALL front speakers) to have your center back speaker(s) play low bass. Use LARGE 1 if you have one center back speaker (6.1) or LARGE 2 (7.1) if you have two center back speakers (7.1). If your center back speakers have limited bass capability or if you would prefer that the bass go to a subwoofer, use the SMALL setting (SMALL1 for one speaker, SMALL2 for two speakers). If your system has no center back speakers, select the NONE setting. With center back speakers, the Rotel XS eXtended surround, Dolby Digital EX, DTS-ES, Dolby Pro Logic II, DTS Neo:6 or other decoders will provide center back signals for any surround mode.

FRONT HEIGHT (large/small/none): Use this setting if you have Front Vertical Height speakers installed in a Pro Logic IIz setup.

SUBWOOFER (yes/no/max): The YES setting is the standard setting if your system has a subwoofer. If your system does not have a subwoofer, select NO. Select the MAX setting for maximum bass output with normal bass being duplicated by both the subwoofer and any LARGE speakers in the system.

C-BACK/F-HEIGHT: Select CENTER BACK if you have center back speakers installed, or FRONT HEIGHT if you have vertical height speakers installed.

ADVANCED: Speaker configuration is generally a global setting for all surround modes and need only be done once. However, for special circumstances, the receiver provides the option of setting the speaker configuration independently for each of four surround modes. Select the ADVANCED line on the menu and press ENT to go to the ADVANCED SPEAKER SETUP menu described in the following section.

To change a setting on the SPEAKER SETUP menu, place the highlight on the desired line using the Up/Down buttons and use the Left/Right buttons to toggle through the available settings. To return to the MAIN menu, press the ENT button. Press the RCVR/SETUP button on the remote to cancel the display and return to normal operation.

Advanced Speaker Setup



In most cases, the standard speaker configuration described above is a global setting and can be used for all surround modes. However, the receiver provides the capability to customize these settings for four different surround modes: Dolby, DTS, Stereo, and DSP. For example, you could set up the Dolby and DTS modes for 5.1 channel sound, while the Stereo mode changes to a 2-speaker setup with or without a subwoofer. In addition, the ADVANCED SPEAKER SETUP allows you to select a customized high-pass crossover frequency for the front, center, surround, and surround back speakers.

Note: In most systems, the default settings on this menu will provide the most predictable results and most users will not need to change any settings. You should fully understand bass management and have a specific reason for needing a custom configuration before changing these settings. Otherwise, skip to the following topic, SUBWOOFER SETUP.

The available settings on the ADVANCED SPEAKER SETUP menu are as follows:

SPEAKER (front/center/surround/center back/subwoofer): Select the set of speakers to be configured with custom settings.

CROSSOVER (40Hz/50Hz/60Hz/70Hz/80Hz/100Hz/120Hz/150Hz/200Hz/OFF): Typically, the RSX-1562 uses a single master setting for the high-pass and low-pass crossover point between all SMALL speakers and the subwoofer. This master crossover point is set on the SUBWOOFER SETUP menu described in the following section. When you first access the ADVANCED SPEAKER SETUP menu, the current master crossover point will be shown on this line. Change the value of this line only if you want the current speaker to have a different crossover point. For example, if your master crossover is set to 80Hz, but you want your front speakers to crossover to the subwoofer at 60Hz, you would select 60Hz for the front speakers on this line. This setting ONLY affects redirected bass and

does not affect the LFE channel in any way. The OFF setting (available only for the subwoofer) sends a full-range signal to your subwoofer so that you can use its built-in low-pass filter.

Note: When a speaker is set to LARGE on the SPEAKER SETUP menu or on this menu, the crossover setting is not available since, by definition, a LARGE speaker plays full-range with no bass redirection to the subwoofer and no crossover. Likewise, the OFF setting for the subwoofer crossover is not available for SMALL speakers, since SMALL means that the speaker will redirect its bass below a given crossover point to the subwoofer. In addition, the CROSSOVER setting is not available for the MULTI INPUT.

DOLBY (large/small/none): Sets the current speaker (shown in the first line) to LARGE, SMALL, or NONE, overriding the master setting from the SPEAKER SETUP menu. This setting will ONLY take effect with Dolby Digital or Dolby Pro Logic II decoding.

DTS (large/small/none): The same options described for Dolby above, except these settings ONLY take effect with DTS and DTS Neo:6 decoding.

STEREO (large/small/none): The same options described for Dolby above, except these settings ONLY take effect in STEREO surround mode.

DSP (large/small/none): The same options described for Dolby above, except these settings ONLY take effect with any of the DSP MUSIC surround modes.

Note: When the front speakers are set to use the master crossover frequency on the Advanced Speaker Setup menu, the surround mode specific “large/small/none” settings are not available for the other speakers. These speakers will use the setting determined in the basic Speaker Setup menu.

Subwoofer Setup

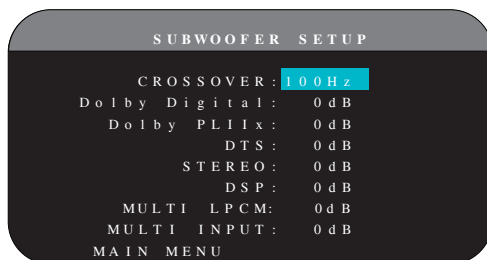

The SUBWOOFER SETUP menu allows selection of the master subwoofer crossover frequency and independent adjustment of subwoofer level for each surround mode.

CROSSOVER (40Hz/50Hz/60Hz/70Hz/80Hz/100Hz/120Hz/150z/200Hz/OFF): This setting specifies a master low-pass filter for the subwoofer and a corresponding high-pass filter for all SMALL speakers in the system at the selected frequency. To adjust the crossover frequency, highlight the CROSSOVER line using the Up/Down buttons. Then, use the Left/Right buttons to choose the master crossover point. The 80Hz or 100Hz crossover points are the most common in home theater systems and should be used unless you have a specific reason to choose a different crossover point based on your specific speakers.

The OFF setting sends a full-range signal to your subwoofer so that you can use its built-in low-pass filter. With the OFF setting, a 100Hz high-pass filter is activated for all SMALL speakers in the system.

Note: The master crossover point can be overridden with a custom crossover frequency for the front, center, surround, or surround back speakers in the ADVANCED SPEAKER SETUP menu; however, in most systems the single master crossover point should work well

DOLBY DIGITAL:

DOLBY PLIIx:

DTS:

STEREO:

DSP:

MULTI LPCM:

MULTI INPUT:

These seven lines allow you to override the master subwoofer level setting as determined on the TEST TONE menu (see next section) for each specific surround mode. When going to the SUBWOOFER SETUP menu from the MAIN menu, the current surround mode is automatically highlighted. Use the </> buttons to adjust the subwoofer level for the current surround mode. The options are OFF (which turns off the subwoofer for that mode) and a range of adjustments from -9dB to +9dB and MAX (+10dB). A setting of 0dB means that the specified surround mode will use the master subwoofer level. Any other setting is an offset to the master setting. For example, an adjustment of -2dB for a particular surround mode means that the subwoofer level will be 2dB quieter than the master subwoofer level when that surround mode is selected. Use these subwoofer level settings to adjust the relative bass output of various surround modes. Changing the master subwoofer level will increase or decrease the level for all surround modes.

Note: Only the current surround mode can be adjusted on this menu. You will need to change surround modes using the front panel or remote buttons to adjust a different mode.

We recommend starting with the settings for all surround modes at the default 0dB setting during the test tone calibration of the system and for a period of familiarization after that. As you listen to a variety of source material over time, you may notice that certain surround modes consistently produce too much or too little bass from the subwoofer. If so, then use these menu settings to customize each surround mode. In general, if the master subwoofer level is set properly (i.e. not too loud), individual settings for each surround mode should not be necessary.

Note: In Dolby Digital and DTS recordings, the LFE channel is used to produce spectacular low bass effects, placing considerable demands on your subwoofer system. If you hear distortion or other signs of distress from your subwoofer at loud listening levels, you may consider reducing the subwoofer level for the Dolby Digital and/or DTS surround modes. In other surround modes, there is no LFE channel and the subwoofer will only reproduce redirected bass from the other channels, which is not as likely to tax the subwoofer.

To return to the MAIN menu, press the ENT button. Press the RCVR/SETUP button on the remote to cancel the menu display and return to normal operation.

Test Tone Setup

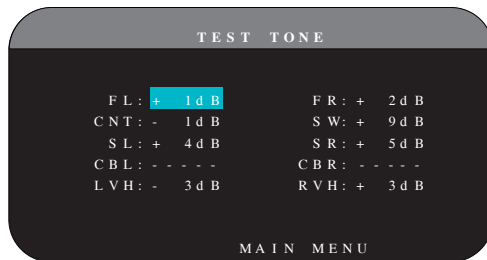

This menu uses filtered pink noise test tones to set equal volume levels for all speakers (left front, center, right front, right surround, center back, left surround, left vertical height, right vertical height and subwoofer) to ensure proper surround sound reproduction. Setting the output levels using the test procedure provides the most accurate adjustment so that digital surround sound material will be reproduced as it was intended and is a critical step in calibrating the system.

Note: If you have configured your system to use two center back speakers, there will be an additional line in the menu, giving you the ability to independently adjust the CENTER BACK 1 and CENTER BACK 2 speakers. If you have selected Vertical Height speakers in Speaker setup, the CENTER BACK speakers will not be adjustable.

To access this menu and perform the test tone calibration, you can be in any surround mode except BYPASS with any input except the MULTI INPUT. Enter the OSD menu system and select TEST TONE from the MAIN MENU to reach this screen.

When you enter the TEST TONE menu, you will hear a test tone coming from the highlighted speaker. Highlight different speakers by moving the cursor to the desired line using the Up/Down buttons. The test tone will shift accordingly to the selected speaker.

Seated in the normal listening location, shift the test tone to the various speakers. Using the one speaker as a reference, listen for any speakers that are noticeably louder or quieter. If so, adjust that speaker's levels up or down (in 1 dB increments) using the Left/Right buttons. Continue switching among the speakers and adjusting until all are the same volume.

To return to the MAIN menu, press the ENT button. Press the RCVR/SETUP button on the remote to cancel the menu display and return to normal operation.

Calibration with an SPL meter:

Calibrating the system with an SPL (Sound Pressure Level) meter, rather than by ear, provides more precise results and improves the system's performance significantly. Inexpensive SPL meters are widely available and the procedure is quick and easy.

Both Dolby and DTS specify a standard calibration level for all theaters to ensure that soundtracks can be played at the volume level intended by the director of the film. This reference level should result in spoken dialog played at a realistic level for normal speech with the loudest peaks in any single channel at about 105dB. The RSX-1562's test tones are generated at a precise level (-30dBfs) relative to the loudest possible digitally recorded sound. At the Dolby or DTS reference level, these test tones should produce a 75dB reading on an SPL meter.

Set the meter to its 70dB dial setting with SLOW response and C-weighting, held away from your body at your listening position (mounting the SPL meter on a camera tripod makes this easier). You can point the SPL meter at each speaker as it is being measured; however, positioning the meter in a fixed position pointing at the ceiling is easier and probably produces more consistent results.

Increase the master volume control on the unit until the meter reads 75dB (+5dB on the meter scale) when playing the test tone through one of the front speakers. Then, use the individual channel adjustments on the TEST TONE menu to adjust each of the individual speakers, including the subwoofer, to the same 75dB on the SPL meter.

Note: Due to meter weighting curves and room effects, the actual level of the subwoofer may be slightly higher than you measure. To compensate, Dolby suggests setting the subwoofer several dB lower when calibrating with an SPL meter (i.e. set the subwoofer to read 72dB on the meter instead of 75dB). Ultimately, the proper subwoofer level must be determined by personal taste and some listeners prefer to set it above 75dB for film soundtracks. Exaggerated bass effects come at the expense of proper blending with the main speakers and place stress on the subwoofer and its amplifier. If you can localize bass from the subwoofer, the subwoofer level may be too high. Music can be useful for fine-tuning the subwoofer level as excessive bass is readily apparent. The proper setting will generally work well for music and movie soundtracks.

Remember the setting of the master volume control used during this calibration. To play a Dolby Digital or DTS soundtrack at the reference volume level, simply return to that volume setting. Note that most home theater listeners find this setting to be excessively loud. Let your own ears be the judge for deciding how loud to playback movie soundtracks and adjust the master volume control accordingly. Regardless of your listening levels, using an SPL meter to calibrate equal levels for all speakers in the system is recommended.

Delay Setup

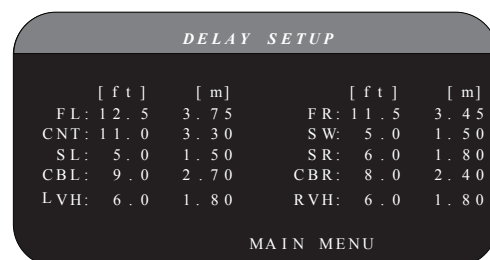







The DELAY SETUP menu, which is reached from the MAIN menu, allows you to set the delay for individual speakers. This ensures that the sound from each speaker arrives simultaneously at the listening position, even when the speakers are not all placed at equal distances from the listener. Increase the delay to speakers located closer to the seating area and decrease the delay to speakers located farther from the seating area.

This Rotel receiver makes setting the delay time for each speaker very easy. Simply measure the distance (in feet or meters) from your seating position to each speaker in your system. Set the measured distance in the line for each speaker. The menu provides a line for each speaker configured in your system and gives a range of settings up to 99 feet (30 meters) in 0.5 foot (0.15m) increments with each increment equivalent to an additional delay of 0.5ms.

To change a setting, place the highlight on the desired line using the Up/Down buttons and use the Left/Right buttons to increase or decrease the delay. To return to the MAIN menu, press the ENT button. Press the RCVR/SETUP button on the remote to cancel the display and return to normal operation.

Tuner Controls

This Rotel receiver features a digital synthesized AM/FM tuner with RDS capability and 30 station presets. The unit offers a wide range of tuning options. Here is an overview of tuning options.

- **Manual frequency tuning** tunes up or down to the next station frequency (when in frequency tuning mode). Press and release a TUNING button (CH +/-  on the remote) to tune.
- **Direct frequency tuning** lets you enter the desired station frequency digits. Press the DIRECT button (or FRQ-D button  on the remote) and enter the digits using the NUMERIC buttons .
- **Automatic frequency search tuning** searches up or down to find the next receivable broadcast signal. Press and hold a TUNING button (CH +/-  on the remote) for at least one second to search up or down.
- **Station preset tuning** lets you directly enter the number of a memorized station preset. Enter the number of the memorized preset using the NUMERIC buttons.
- **Preset tuning** jumps up/down to the next memorized station preset. When in PRESET mode, press a TUNING button (CH +/-  on the remote) to select the next station preset. Press the P-TUN button  on the remote to toggle between preset and frequency tuning modes.
- **RDS (Europe) or RBDS (USA) tuning** provides a range of special tuning and search features based on data codes encoded with the broadcast signal. See the RDS section of this manual for detailed information.

Note: The receiver comes configured for tuning in the market where you purchased it. (N. America or Europe). To change this default setting, see the information on the DEFAULT SETUP on-screen menu later in this manual.

BAND Buttons

Press the BAND button to toggle between AM and FM reception. An indicator in the front-panel display confirms your choice and the currently tuned station frequency is shown.

TUNING Buttons

The TUNING buttons (CH +/-  on the remote control) provide three different tuning functions, depending on the mode of operation.

In the normal FREQUENCY tuning mode, press a TUNING button (CH +/-  on the remote) and release to manually jump to the next station frequency, regardless of whether or not a station is broadcasting on that frequency. For auto frequency search tuning, press and hold the TUNING button for approximately one second. An AUTO indicator will appear in the front-panel display and the tuner

will begin scanning up or down through the frequencies until the next available signal is detected. If this is not the desired station, repeat the automatic tuning procedure to find the next station. Weak stations will be skipped during auto tuning.

In the PRESET tuning mode, press a TUNING button (CH +/-  on the remote) and release to jump to the next memorized station preset.

Note: Toggle between FREQUENCY and PRESET tuning by pressing the P-TUN button  on the remote.

In the RDS PTY search mode, press a TUNING button (CH +/-  on remote) to select the desired program type from the scrolling list in the display. See the section on RDS tuning for more details.

MEMORY Button

The MEMORY button (labeled MEM on the remote) is used with the NUMERIC buttons to store memorized station presets. See the next section for detailed instructions.

NUMERIC Buttons : Station Presets

The receiver can store up to 30 station presets for recall at any time using the NUMERIC buttons on the front panel. To memorize a station:

1. Tune to the desired station, AM or FM.
2. Press the MEMORY button (MEM on remote). A MEMORY indicator will flash for five seconds in the front-panel display.
3. While the MEMORY indicator is flashing, press the number of the preset where you wish to store the station frequency. For example, to memorize the station as preset 3, press the 3 button. To memorize preset 15, press the 1 button followed by the 5 button.
4. A previously stored frequency is erased from memory when a new frequency is memorized for the same preset number.

To tune to a previously memorized station, just press the preset number on the NUMERIC buttons. For example, to tune to preset 3, press the 3 button. To tune to preset 15, press the 1 button and then press the 5 button.

Note: If the TUNER is not already the selected input, pressing a NUMERIC button on the front-panel activates the TUNER. If using the NUMERIC buttons on the remote, first manually select the tuner input (press TUN button ) , if not already activated.

The NUMERIC buttons can also be used for direct access tuning (see next section)

DIRECT Button FRQ-D Button ("10+" key)

If you know the frequency of the desired station, you may tune it directly using the DIRECT button and the NUMERIC buttons.

1. Press the DIRECT button on the front panel or the FRQ-D button on the remote to change the NUMERIC buttons from station preset to Direct Access mode. The station frequency in the front panel display will change to a series of four bars, representing the digits of a station frequency, with the first bar flashing.

2. Enter the first digit of the station frequency using the NUMERIC buttons. The digit will appear in the frequency display and the second bar will flash. Enter the remaining digits of frequency. When all of the necessary digits have been entered, the receiver will tune to the displayed station frequency. Note that entering a station frequency is slightly different for the USA and Europe.

In the USA:

FM87.50MHz	Press: 8>7>5
FM101.90MHz	Press: 1>1>9
AM1410Hz	Press: 1>4>1

In Europe:

FM87.50MHz	Press: 8>7>5>0
FM101.90MHz	Press: 1>1>9>0
AM1410Hz	Press: 1>4>1>3

MONO Button

The MONO button on the front panel change the FM mode from stereo reception to mono reception. In stereo mode, a stereo signal will be heard if the station is broadcasting a stereo signal and there is sufficient signal strength. An ST indicator will light in the front panel display. In mono mode, a mono signal will be heard even if the station is broadcasting a stereo signal.

Note: Switching to mono mode can improve the reception of weak or distant FM signals. Less signal strength is required for clean mono reception than for stereo reception.

RDS and RBDS Tuning

This Rotel receiver is equipped with RDS (Radio Data Systems) reception capabilities for Europe and RBDS (Radio Broadcast Data Service) capabilities for the United States. These broadcast systems provide additional functionality to FM radio reception by transmitting encoded information along with the radio signal. This signal is decoded by an RDS or RBDS receiver and can provide a range of informational features including:

1. A display of station's identifying name (e.g. BBC1).
2. A display of the station's program content (e.g. ROCK or NEWS)
3. Traffic information broadcasts.
4. A scrolling text display for announcements or information.
5. Search for a station with the desired program content (PTY)

RDS broadcasting has been widely available in many European markets for years. There are a large number of RDS stations and most users will be familiar with the features and operation. In the USA, implementation of RBDS system is more recent. Fewer stations are broadcasting RBDS signals and the feature may be less familiar to many users. Consult your authorized Rotel dealer for more information on RDS or RBDS broadcasting in your area.

Note: The RDS and RBDS features are entirely dependent on the broadcaster sending encoded signals. Thus, they will only be available in markets where RDS or RBDS is implemented and where

stations are broadcasting there data signals. If there are no RDS or RBDS stations, the unit will function as a standard radio receiver.

Note: RDS and RBDS services are only available on FM broadcasts. The features and buttons described below are only operational in FM mode.

DISP Button

There are five display options when the currently tuned station is broadcasting RDS information and the RDS indicator in the front panel display is lit. Press the DISP button on the remote to step through the five display options:

1. Standard FREQUENCY display.
2. PROGRAM SERVICE name. This is typically the station's call letters, such as BBC1. If the current station is not broadcasting an RDS signal, the display will show "NO NAME DATA".
3. PROGRAM TYPE. This is the description of the station's content from a standardized list of program types in each market. If the current station is not broadcasting an RDS signal, the display will show "NO PTY DATA".
4. CLOCK TIME. A time and date display broadcast by the station. If the current station is not broadcasting an RDS signal, the display will show "NO TIME DATA".
5. RADIO TEXT. Additional scrolling text messages broadcast by the station. If the current station is broadcasting radio text data, an RT indicator lights in the display and the scrolling text appears. If the current station is not broadcasting an RDS signal, the display will show "NO TEXT DATA".

PTY Button

The PTY search function permits you to scan available broadcasts for RDS stations broadcasting a particular type of program content.

1. Press the PTY button. The current RDS program type will appear in the display.
2. If desired, change to a different PROGRAM TYPE using the TUNING UP/DOWN buttons to scroll through the list.
3. Press the PTY button a second time within 10 seconds. The tuner will attempt to find an RDS station broadcasting the selected type of program. If the button is not pressed within 10 seconds after selecting a program type, the PTY function will be cancelled.
4. If no station is located for the desired content type, the tuner will return to the last previously tuned station.
5. Cancel the PTY function by pressing any other button.

Note: If the currently tuned station is broadcasting PTY data, a PTY indicator lights in the front panel display.

Miscellaneous Settings

Other Options

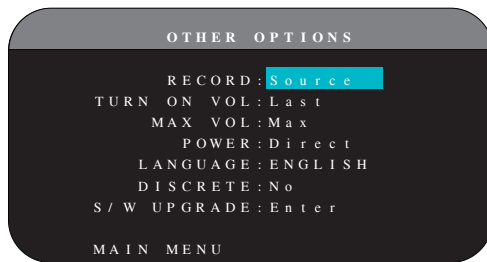

This OTHER OPTIONS menu, accessed from the MAIN menu, provides access to several miscellaneous settings as follows:

RECORD: Select which source signal to be sent to the recording outputs by choosing one of the input sources. The options are: CD, TUNER, VIDEO 1–6, USB, and SOURCE. You can either select a specific component or select SOURCE which will send the signal to the record outputs from whatever source is selected for listening. The default is SOURCE.

TURN ON VOL: Specifies a default volume level to be used each time the unit is activated. You can select LAST to have the unit power up with the last previously used volume setting. Or, you specify a volume from MIN (full mute) to MAX, in 1 dB increments. Note that this setting cannot exceed the MAX VOL established in the next line of the menu.

MAX VOL: Specifies the maximum volume level for the unit. The volume cannot be adjusted above this level. Settings range from MIN to MAX, in 1 dB increments.

POWER: This setting determines how the unit powers up. With the default STANDBY setting, the unit powers up in standby mode when AC is applied and the rear panel POWER button is ON. The unit must be activated using the front panel STANDBY button or the remote ON/OFF buttons.

With the DIRECT setting, the unit is fully activated when AC power is applied and the rear panel POWER button is ON; however, it may be put in standby mode using the front panel STANDBY button or the remote ON/OFF buttons.

In ALWAYS-ON mode, the unit remains fully active whenever AC is present and the rear panel POWER button is ON; the front panel STANDBY button and the remote ON/OFF buttons are disabled and the unit cannot be put in standby mode.

In RESUME mode, the unit will return to the last power condition setting when switched on. For example, when the AC mains power is switched OFF during operation, it will return to operating mode when the mains power is switched on again.

LANGUAGE: Selects a language for the On Screen Display

DISCRETE: The default setting of NO allows control of input selection in remote ZONE 2–4 from the main room remote control. Changing the setting to YES prevents the remote control in the main room from affecting any remote monitors in any way.

Note: The DISCRETE function is intended for use by a Rotel dealer or installer only.

Rotel's use of discrete IR commands in multi-zone models provides easier integration with IR control systems, making control possible from a single IR input. For Rotel dealers or installers, further information is available on the Rotel website: www.rotel.com

Go to 'Support' for downloads and technical updates, or search for 'discrete' to find relevant items. Remote commands are available in Philips Pronto CCF format and in RTI CML format at:

www.rotel.com/downloads/prontocodes.htm

www.rotel.com/downloads/rticodes.htm

S/W UPGRADE : Enter this menu if you wish to upgrade the unit's firmware.

Note: The S/W UPGRADE function is intended for use by a Rotel dealer or installer only.

Change settings on the OTHER OPTIONS menu by highlighting the desired line using the Up/Down buttons and using the Left/Right buttons to step through the available settings. To return to the MAIN menu, press the ENT button. Press the RCVR/SETUP button on the remote to cancel the display and return to normal operation.

Video/HDMI SETUP

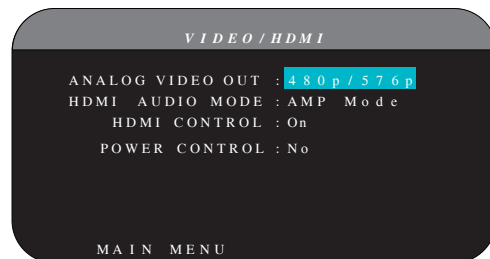

The VIDEO/HDMI menu deals with the configuration of the HDMI output for high-definition video display devices. See the Video Inputs & Outputs section of this manual.

ANALOG VIDEO OUT: Specifies the video resolution and format of the analog video output at the TV MONITOR outputs. The receiver will scale all analog video inputs up to this specified resolution for a perfect match with the native resolution of your HDTV monitor. Can be 480p/576p, 720p, 1080i, 1080p.

HDMI AUDIO MODE: options are AMP MODE and TV MODE. In AMP MODE the HDMI Audio and other audio (analog or digital) inputs are processed and sent by the RSX-1562 for output to the connected amplifier(s). TV MODE (pass-through) provides HDMI Audio and other audio (analog or digital) outputs for use with an audio-capable display device. In TV MODE, there is no audio output from the RSX-1562.

HDMI CONTROL: Options are On, Off. Set to On to enable the ARC (Audio Return Channel) feature. For ARC to function, your display (TV, monitor) must be ARC capable and must be connected the RSX-1562's HDMI OUT 1 (labeled ARC). ARC allows the RSX-1562 to receive the audio signal from the TV's tuner through the HDMI OUTPUT 1 of RSX-

1562. This allows the audio from the TV to be played through your hometheater system.

Note: When ARC is enabled, the Rotel unit will play the audio from the TV. The volume can be controlled by the TV's remote control.

Note: When HDMI control is ON, the unit will pass HDMI Video and Audio signals in Standby mode direct to the TV. The Rotel unit do not have to be powered on if you only want to use the speakers of the TV for audio. But the Rotel unit must be set to the correct input prior to standby.

POWER CONTROL: Options are Yes, No. Selecting Yes, allows other HDMI enabled units in your system to turn the RSX-1562 on or off. In normal operation, powering ON the source will also turn on the RSX-1562 and the TV. Turning the TV off, will turn off the RSX-1562 and the source.

Note: For power control to operate, all components in the system must have power control enabled from source to displays. Although the unit has been tested with most major brands of displays and sources, there may still be occasional compatibility problems.

Zone 2-4 Setup

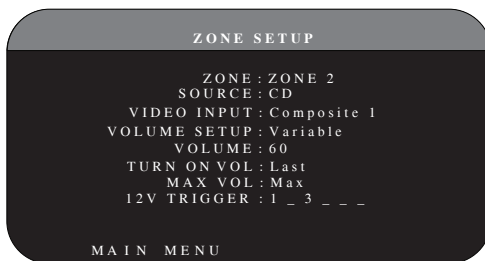

The ZONE SETUP menu provides settings and configuration options related to the operation of the remote zones. This menu is reached by highlighting the ZONE line on the MAIN menu and pressing ENT.

ZONE: Specifies the zone to configure, ZONE 2, 3, or 4. Each zone is configured individually.

SOURCE: Specifies a source for listening in the selected zone. Options are CD, TUNER, VIDEO 1-6, SOURCE, and OFF. Selecting the SOURCE option links the zone source to the source selected for the main zone so that the remote zone will hear the same source as the main zone. Selecting the OFF option turns the zone off.

VIDEO INPUT: Specifies a video source (Composite Video only) for the selected zone. The options available are Composite 1, 2 and OFF.

VOLUME SETUP: Configures the remote zone outputs for VARIABLE or FIXED volume levels. VARIABLE allows control of the volume settings in the remote zone from the RSX-1562's front panel or from a remote control/IR repeater in the zone. FIXED output disables the volume control. In this mode, the remote zone level can be fixed at the level specified on the next line, thus optimizing system performance when sending a fixed level signal to a preamp or amplifier with its own volume adjustment.

VOLUME: In VARIABLE output mode, this line shows the current volume setting for remote zone. In FIXED output mode, this volume setting establishes a permanent fixed output level for the remote zone

TURN ON VOL: Specifies a default volume level to be used each time the remote zone is activated. You can select LAST to have the zone activate with the last previously used volume setting. Or, you specify a volume from MIN (full mute) to MAX, in 1dB increments. Note that this setting can not exceed the MAX VOL established in the next line of the menu.

MAX VOL: Specifies the maximum volume level for the remote zone. The volume cannot be adjusted above this level. Settings range from MIN to MAX in 1dB increments.

12V TRIGGER: The RSX-1562 has six 12V trigger outputs (labeled 1–6) that supply a 12V DC signal to turn on Rotel components and other components as needed. This menu item turns on specific 12V trigger outputs whenever the indicated zone is activated. The six 12V Trigger outputs may be assigned to each zone and can send a turn-on signal to remote components whenever the remote zones are activated. For example, ZONE 2 could use 12V Triggers 1, 3 and 6; ZONE 3, 12V Triggers 2 and 3; ZONE 4, 12V Triggers 5 and 6.

1. Press the Left/Right buttons on the remote to change the first position from blank to 1 (activating TRIGGER 1 for that zone).
2. Press the ENT button on the remote to move to the next position.
3. Repeat until all six positions are set as desired. A final press of the ENT button confirms the selection.

Default Setup



The DEFAULT SETUP menu provides access to six functions:

- Set the tuning function for North America or European frequencies.
- Redirect the Front channel amplifiers or the Center Back channel amplifiers to power remote speakers in Zone 2, 3 or 4, or redirect the Center Back channel amplifiers to "Front" for bi-amping.
- Restore all features and settings to the original FACTORY DEFAULT settings.
- Memorize a custom group of settings as a USER DEFAULT.
- Activate the memorized USER DEFAULT settings.
- Set a NEW PASSWORD for the memorized USER DEFAULT settings.

To change the TUNER setting: Place the highlight on the TUNER setting line using the Up/Down buttons and use the Left/Right buttons to change the setting to N. AMERICA or EUROPE. Then, move the highlight to the FACTORY DEFAULT line and change the setting to YES, using the

Left/Right keys, then press the ENT button. The screen will change to a confirmation screen. Press the ENT button to proceed with resetting the FACTORY DEFAULT settings and changing the TUNER DEFAULT. To return to the MAIN menu without resetting the FACTORY DEFAULT and TUNER settings, change the entry to NO and press the ENT button.

To change the REDIRECT setting: Place the highlight on the REDIRECT line using the Up/Down buttons and use the Left/Right buttons to change the setting from REDIRECT : NO, to REDIRECT:Front>Zone 2, Front>Zone 3, Front>Zone 4, CB/FH>Zone 2, CB/FH>Zone 3 or CB/FH>Zone 4 (for powering speakers in one of the remote Zones 2, 3 or 4), or CB>Front (for bi-amping front speakers). If you choose to redirect the internal front channel amplifiers, then you will need a separate stereo amplifier to driver you front speakers.

Note: Changing the default TUNER SETTING or REDIRECT SETTING can only be done at the same time as restoring the FACTORY DEFAULT settings. Therefore, we recommend selecting your default TUNER and REDIRECT settings and resetting to the FACTORY DEFAULT settings as the first step in configuring the unit, before you change or memorize any other configuration settings.

To restore the FACTORY DEFAULT settings: Place the highlight on the FACTORY DEFAULT line using the Up/Down buttons and use the Left/Right buttons to change the setting to YES. Press the ENT button on the remote to proceed with resetting to FACTORY DEFAULT. A re-confirmation screen will appear, please select YES. The unit will power off (to Standby Mode) and then on, with the factory settings restored. To return to the MAIN menu without resetting the FACTORY DEFAULT settings, change the entry to NO and press the ENT button.

Note: Resetting to factory default settings will erase all stored settings including delay settings, speaker settings, balance settings, input settings and more. You will lose ALL system configuration settings. Be certain that you wish to do so before resetting the factory defaults. If you have memorized a USER DEFAULT setting, this will be retained even after factory default.

To memorize USER DEFAULT settings: Many of the current configuration settings can be stored as a USER DEFAULT, which can be activated at any time from this menu screen. To save the current settings as a USER DEFAULT:

1. Place the highlight on the SET USER DEFAULT line using the Up/Down buttons and use the Left/Right buttons to change the setting to YES.
2. Press the ENT button on the remote to go to confirmation screen where a password must be entered. The default password is 0000. If the entered password is correct, the current settings will be saved as the new USER DEFAULT settings.
3. To return to the MAIN menu without saving changes, change all entries on the screen to NO and press ENT.

Note: If there is insufficient memory to store a USER DEFAULT configuration file, the SET USER DEFAULT option will not be available.

To activate memorized USER DEFAULT settings: After you have stored a USER DEFAULT configuration file, you can activate those settings at any time by placing the highlight on the USER DEFAULT line using the Up/

Down buttons. Use the Left/Right buttons to change the setting to YES. Press the ENT button on the remote to proceed with activating the USER DEFAULT settings.

To return to the MAIN menu without activating the USER DEFAULT settings, change the entry to NO and press the ENT button.

To change the password: The password programmed at the factory is 0000. If you wish to change the password:

1. Place the highlight on the SET NEW PASSWORD line using the Up/Down buttons. Use the Left/Right buttons to change the setting to YES. Press the ENT button on the remote to proceed to the PASSWORD screen.
2. Enter the four digits of the old password by pressing the Left/Right buttons to select the first letter of the new password, then pressing ENT to move to the second character. Repeat until the old password is entered. Successful entry of the old password will jump to the ENTER NEW PASSWORD line.
3. Enter the four digits of the new password by pressing the Left/Right buttons to select the first letter of the new password, then pressing ENT on the remote to move to the second character. Repeat until the new password is entered.
4. You will be asked to re-enter the password again on the CONFIRM PASSWORD line, following the same procedure. Once the password is successfully confirmed, it will be saved and you will return to the DEFAULT SETUP MENU automatically.
5. To exit the PASSWORD screen without changing the password, highlight the DEFAULT SETUP MENU line and press ENT to return to the previous screen.

Note: The factory password is 0000. A default password that will always be recognized is 8888.

EQ Setup

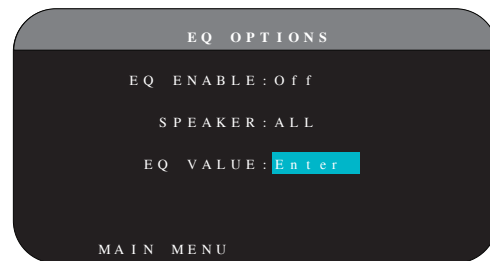

The EQ Setup menu provides access to three functions:

EQ ENABLE: Select either ON or OFF to turn on/off the EQ feature.

SPEAKER: Select either ALL or Individual speakers using Left/Right keys.

EQ VALUE: This menu allows you to enter the EQ value. There are total 10 bands as below.

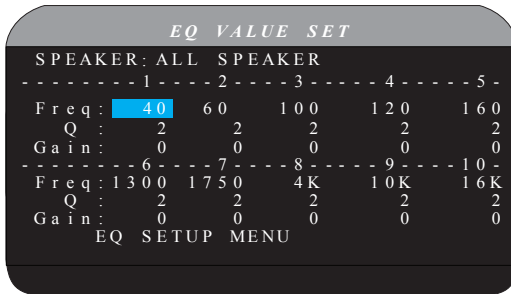

BAND 1 Freq : 20Hz - 80Hz, 1Hz Step	Default 40 Hz
BAND 2 Freq: 20Hz - 80Hz, 1Hz Step	Default 60 Hz
BAND 3 Freq: 81Hz - 140Hz, 1Hz Step	Default 100 Hz
BAND 4 Freq: 81Hz - 140Hz, 1Hz Step	Default 120 Hz
BAND 5 Freq: 141Hz - 200Hz, 1Hz Step	Default 160 Hz
BAND 6 Freq: 1110Hz - 1550 Hz, 10Hz Step	Default 1300 Hz
BAND 7 Freq: 1560Hz - 2000 Hz, 10Hz Step	Default 1750 Hz
BAND 8 Freq: 2.1kHz - 8kHz, 100Hz Step	Default 4k Hz
BAND 9 Freq: 8.1kHz - 14kHz, 100Hz Step	Default 10k Hz
BAND 10 Freq: 14.1kHz - 20kHz, 100Hz Step	Default 16k Hz
Q : 1 - 24	
Gain : -12dB - 0 - +3dB	

Note: Q in EQ value relates to the bandwidth of the filter. The higher the value, the narrower the bandwidth.

Troubleshooting

Most difficulties in audio systems are the result of incorrect connections, or improper control settings. If you encounter problems, isolate the area of the difficulty, check the control settings, determine the cause of the fault and make the necessary changes. If you are unable to get sound from the unit, refer to the suggestions for the following conditions:

The unit does not turn on

- Make sure the power cord is plugged into the rear panel and a AC outlet.
- Make sure the rear panel POWER switch is in the ON position.

No sound from any input

- Make sure that MUTING is off and VOLUME is turned up.
- Make sure that preamp outputs are connected to a power amplifier and that the amplifier is turned on.
- Make sure source inputs are connected and configured correctly.
- Check that the setting for HDMI AUDIO in the VIDEO/HDMI on-screen menu is AMP MODE.

No sound from digital sources

- Make sure that digital input connector is assigned to the proper source input and that the source input is configured to use the digital input rather than an analog input.
- Check the configuration of the DVD player to ensure that the bitstream and/or DTS digital output is activated.

No sound from some speakers

- Check all power amp and speaker connections.
- Check Speaker Configuration settings in the Setup menus.

No video output on TV monitor.

- Make sure that the TV monitor is connected properly and check the input assignments. Composite Video TV monitors can only be used with interlaced SD sources. HDMI and Component TV monitors can be used with Standard Definition (SD) and High Definition (HD) sources. An HDMI 1080p source can only be sent to a 1080p-compliant TV monitor .
- Component Video output at 720p or 1080i may not be available if the source signal includes HDCP copy protection.
- HDMI cables must be 5 meters or less in length.
- If watching 3D source, make sure the display is 3D enabled.

Video and Audio do not match.

- Check that the proper video source is selected for each input.
- Check that the group delay (lip-synch) setting is not mis-adjusted.

Clicking or popping sounds when switching inputs

- The unit uses relay switching to preserve maximum sound quality. The mechanical clicking of the relays is normal.
- During switching, it may take a split second for digital signals to be recognized and properly decoded. Rapid repeated switching between inputs or settings can result in clicks or pops from the speakers as the unit attempts to lock on to the rapidly changing signals. This causes no harm.
- Switching between HDMI sources may cause delays as HDMI two way communications "handshake" must be established between the source and display. The time required for the handshake varies from equipment.

Controls do not operate

- Make sure that fresh batteries are installed in the remote.
- Make sure that the IR sensor on the front panel is not blocked. Aim the remote at the sensor.
- Make sure the sensor is not receiving strong IR light (sunlight, halogen lighting, etc.)
- Unplug the unit from the AC outlet, wait 30 seconds, and plug it back to reset.

No video from ZONE 2, 3 or 4

- Check ZONE SETUP configuration and ZONE video input setting assigned and make sure that a video source is connected.

HDMI: Frequently Asked Questions

What is HDMI?

HDMI (High-Definition Multimedia Interface) is an advanced type of connection which carries both video and audio in a single cable. It is a modern digital replacement for older analog video connection standards such as Composite Video, S-Video and Component Video. This Rotel unit meets the latest version of HDMI specification, HDMI 1.3, and HDMI 1.4 with 3D support and Audio Return Channel.

What is the difference between HDMI and DVI?

An earlier digital connection standard, DVI (Digital Visual Interface) can also be used for high-definition video signals by means of a suitable adaptor. However, unlike HDMI, the DVI connection does not also carry audio signals, nor does it automatically set the picture screen to the correct size.

What is the difference between HDMI 1.4, HDMI 1.3 and earlier versions?

If you have a Blu-ray player, note that the HDMI 1.3 connection can carry the new Dolby TrueHD and DTS HD Master Audio formats used on Blu-ray discs. This receiver is able to decode and replay these 7.1 channel audio formats. HDMI 1.4 includes additional features such as 3D video pass through for movies, games and broadcasts.

Also with Blu-ray, but depending on the monitor being used to view the picture, you may also be able to enjoy video enhancements such as Deep Color or XY video (also called Broad Color Space). Using the HDMI 1.4 connection, the RSX-1562 can pass these signals through from the Blu-ray player to a compatible monitor.

These new audio formats and video features are not available from standard DVD discs or players, even when an HDMI connection is used.

Can I connect components which have earlier versions of HDMI?

Yes, because HDMI is backwards-compatible. This means that components which have earlier versions of HDMI (such as HDMI 1.1 or HDMI 1.2) will perform correctly when connected to the HDMI 1.4 inputs or outputs of the unit.

If your DVD player is equipped with HDMI 1.2a, the HDMI connection will permit the transmission of 1080p (high definition) video signals.

Which is the best way to rescale the picture?

When using legacy components that require picture rescaling, it is better to use the monitor scaler to handle any picture resizing. You should try to use only one scaler in the system, so keep your DVD player set to 480p or 1080p. A 480p signal will be rescaled by the monitor and a 1080p signal will be seen by a monitor with 1080p resolution as a native signal.

Some Blu-ray and HD-DVD discs have been recorded in 1080i. These should not be scaled, but are best left to the monitor to interpret into an appropriate format for the screen.

Will the HDMI digital output improve the picture quality from old analog sources?

Analog picture sources from legacy units begin by being less good than digital signals, and while the RSX-1562 will translate them into a digital format, the final quality will be constrained by the original source, and the choice of connection (Composite or Component). The scaler cannot

correct for low resolution signals and will not improve inherently poor picture quality.

Why does the HDMI connection sometimes not give a picture?

Although it is simple to use, the HDMI connection is actually a highly complex electrical circuit, and within it is a security system called HDCP (High Definition Content Protection). In some circumstances pictures may not reproduce, or may not reproduce properly, due to the action of DRM (Digital Rights Management) or the 'handshake' between the two connected units. HDMI cables contain circuits that exchange a 'handshake' signal several times a second, designed to maintain the integrity of the transmission signal and to prevent attempted unauthorized copying of copyright material. However, these 'handshake' signals can be disrupted for several reasons. If problems persist, consult your Rotel dealer.

Specifications

Audio

Continuous Amplifier Power (seven channels driver)
100 watts/ch (20-20k Hz, <0.05% THD, 8 ohms)

Continuous Amplifier Power
200 watts (1 kHz, <1.0% THD, 4 ohms, DIN)

Total Harmonic Distortion
<0.008%

Intermodulation Distortion (60Hz:7kHz)
<0.008%

Frequency Response
10Hz - 120kHz, ± 3 dB (analog bypass)
10Hz - 95kHz, ± 0.3 dB (digital input)

Signal to Noise Ratio (IHF A-weighted)
95dB (analog bypass)
92dB (Dolby Digital, DTS) 0 dBFs

Input Sensitivity/Impedance
Line Level: 200 mV/100k ohms

Preamp Output Level/Output Impedance
1.0V/1k ohms

Decodable Digital Input Signals
Dolby Digital, Dolby Digital EX, DTS, DTS-ES, DTS 96/24, DTS-ES 96/24, LPCM (up to 192k). Lossless audio formats (using HDMI 1.3): Dolby TrueHD and DTS HD Master Audio.

Decodable USB/iPod Digital Input Signals
AAC(m4a), WAV, MP3, WMA

Video

Input Resolutions
480i/576i, 480p/576p, 720p, 1080i
1080p, 1080p 24Hz, 3D (HDMI only)

Output Resolution
480i/576i (Composite only), 480p/576p, 720p, 1080i
1080p, 1080p 24Hz, 3D (HDMI only)

Signal to Noise Ratio
45dB

Input Impedance
75 ohms

Output Impedance
75 ohms

Output Level
1.0 volt

HDMI Inputs/Outputs

Version 1.3, supporting Deep Color passthrough and Broad Color Space passthrough.
Version 1.4, supporting 3D passthrough and Audio Return Channel

FM Tuner

Usable Sensitivity
14.2dBf

Signal to Noise Ratio (at 65dBf)
70dB

Harmonic Distortion (at 65dBf)
0.03%

Stereo Separation (1 kHz)
45dB

Output level
1V

Antenna Input (unbalanced)
75 ohms

AM Tuner

Sensitivity
50 μ V/m

Signal to Noise Ratio
40dB

Output Level
500 mV

Antenna Input
Loop Antenna

General

Power Consumption
500 watts
0.5 watt (standby)

Power Requirements (AC)
120 volts, 60Hz (USA version)
230 volts, 50Hz (EC version)

Weight
15.5kg/34.17 lbs

Dimension (W x H x D)
431 x 188 x 422 mm
17 x 7 $\frac{1}{2}$ x 16 $\frac{5}{8}$ in

Front Panel Height (feet removed/for rack mount)
4U/176.8mm/7 in

When sizing openings in custom cabinets, measure the unit to be installed and/or allow at least 1mm clearance on all sides for unit to unit tolerances. All specifications are accurate at the time of printing. Rotel reserves the right to make improvements without notice.

Rotel and the Rotel Hifi logo are registered trademarks of The Rotel Co., Ltd. Tokyo, Japan.



ROTEL®

The Rotel Co. Ltd.

Endo TN Building 2F.,
6-12-21, Meguro-Honcho,
Meguro-Ku, Tokyo 152-0002
Japan

Rotel of America

54 Concord Street
North Reading, MA 01864-2699
USA
Phone: +1 978-664-3820
Fax: +1 978-664-4109

Rotel Europe

Dale Road
Worthing, West Sussex BN11 2BH
England
Phone: + 44 (0)1903 221 761
Fax: +44 (0)1903 221 525

Rotel Deutschland

Vertrieb: B&W Group Germany GmbH
Kleine Heide 12
D-33790 Halle/Westf., Deutschland
Tel.: 05201 / 87170
Fax: 05201 / 73370
E-Mail: info@bwgroup.de
www.rotel-hifi.de

www.rotel.com

Made for

 iPod  iPhone

"Made for iPod," and "Made for iPhone," means that an electronic accessory has been designed to connect specifically to iPod or iPhone, respectively, and has been certified by the developer to meet Apple performance standards. Apple is not responsible for the operation of this device or its compliance with safety and regulatory standards. Please note that the use of this accessory with iPod, or iPhone may affect wireless performance.

iPhone, iPod, iPod classic, iPod nano, and iPod touch are trademarks of Apple Inc., registered in the U.S. and other countries.