



HYPHN

Product Manual

Register your Hyphn speakers
to ensure the best possible product and customer support

Register your speakers using the QR code
or visit **monitoraudio.com/registration**



Welcome to Hyphn

Thank you for purchasing our Hyphn speaker system, you're now ready to start your journey to breathtaking sound.

Hyphn is a peerless, definitive, uncompromising demonstration of the Monitor Audio Group's current design, engineering and manufacturing capabilities, and its future ambitions. It is unlike anything Monitor Audio, or anyone else, has ever created: the most creatively ambitious, technically advanced and powerful loudspeaker in the company's history.

In this product manual, you'll find information about setting up your system and how to maintain your speakers for a lifetime of enjoyment.

If you need any further assistance, please contact our technical team at **monitoraudio.com/hyphn-support**

Contents

Unboxing	2
Setting up your system	4
Spikes & feet	6
Wiring your speakers	8
Using your speakers	10
Care & maintenance	11
Warranty	12
Specifications	13

⚠ WARNING: DO NOT attempt to lift the loudspeaker alone.
We strongly recommend at least four people to unpack and manoeuvre them.

It is strongly recommended to place each loudspeaker relatively close to the optimum listening position when unpacking to minimise the amount they have to be moved.

The handles on the sides of the cartons can be used to lift the carton into position.

Hyphn Sliders are provided in box B to ease the loudspeakers into their final position.

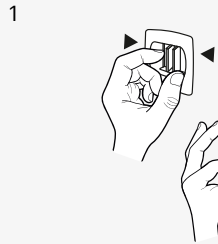

Remove clips from box

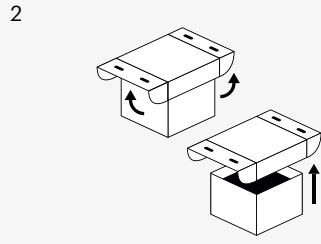

Remove lid from box

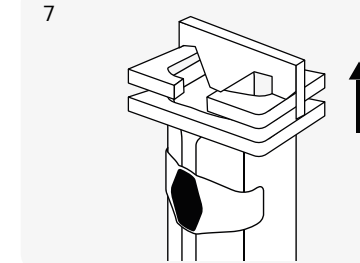

Remove top foam

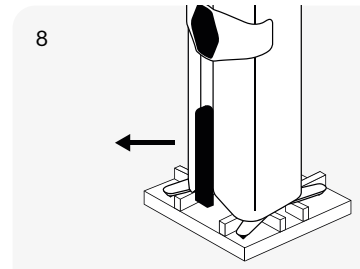

Remove middle foam

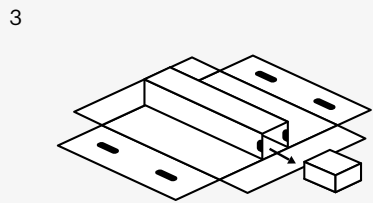

Remove Tool Box & Hyphn Sliders from both lids

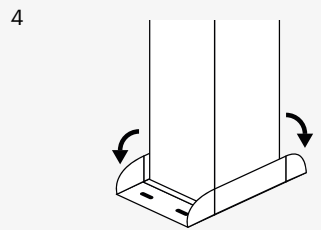

Fold down bottom tray

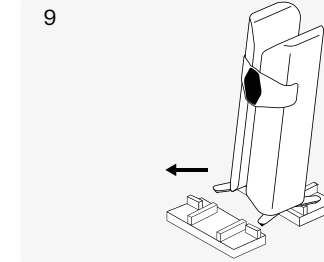

Tilt speaker back and remove foot foam

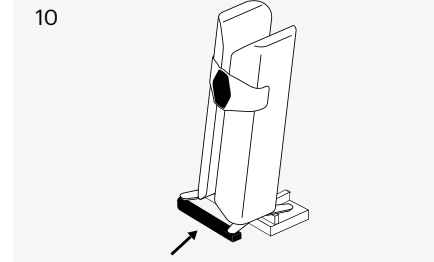

Use middle foam to support front feet

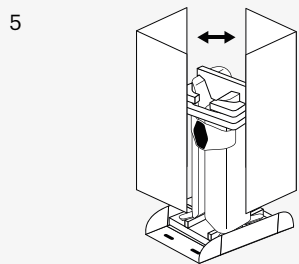

Remove side panels

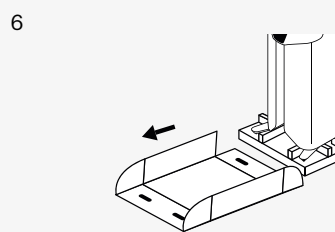

Slide product off tray

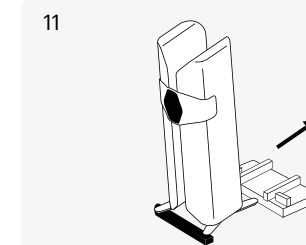

Tilt speaker forward and remove foot foam

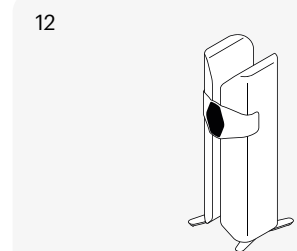

Tilt speaker back to upright position

2-channel system

With the speaker sitting on the Hyphn Sliders, it is possible to “slide” the speaker into position with massively reduced resistance, other than the weight of the speaker across hard or carpeted floors.

When arranging a 2-channel system, the listening position and the loudspeakers should form an equilateral triangle. Ideally the loudspeakers should be positioned approximately 1.8 - 3m (6 - 10 feet) apart and a minimum of 91cm (3 feet) from the side walls. The ideal distance from the rear wall is 91cm (36 inches).

NOTE: These are recommended distances for optimal performance.

Actual results will vary dependant on room size, construction and personal tastes.

Experimentation is strongly advised when setting up the loudspeakers, as environment and personal preference will differ with every installation.

Listen to a few familiar songs, making sure you are happy with the speaker position before removing the Hyphn Sliders.

To enhance stereo imaging, try ‘toeing’ the loudspeakers in towards the listening area. Sounds that are recorded equally to each channel should sound as though they are coming from the space between the speakers.

Use the diagram opposite for suggested positioning of the speakers.

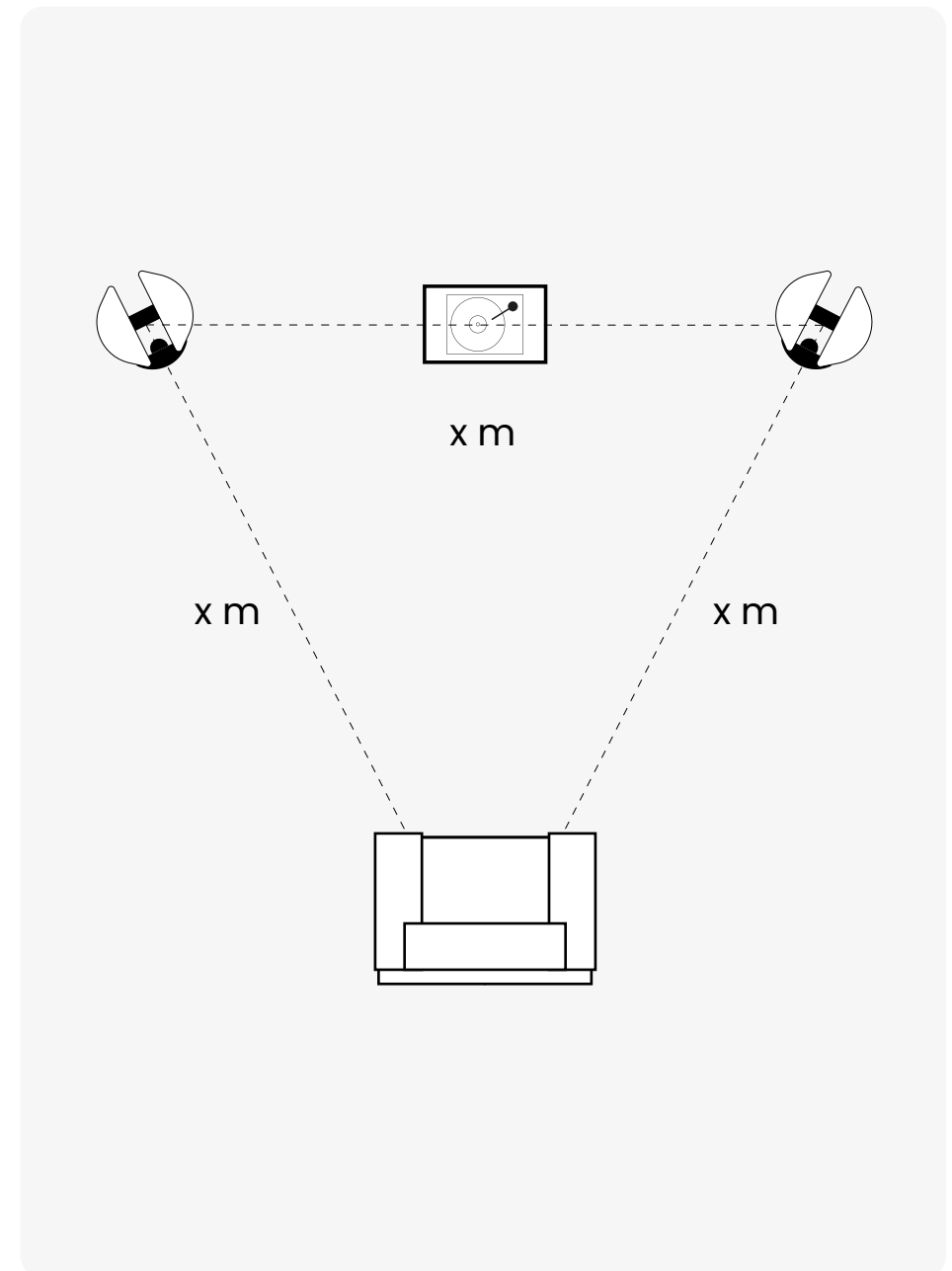

Use on carpeted floors

The outriggers are supplied assembled with spikes, fitted to the cabinet for use on carpeted floors. All that is required is to position the loudspeaker in its listening position, and check it is level and stable.



Please ensure there are no hidden wires under the carpet that could be damaged by the spikes.

Use on wooden or hard floors

If the loudspeaker is being installed on a wooden or hard floor, use the supplied foot cups underneath the spike to protect the floor. Position the loudspeaker in its listening position and check it is level and stable.

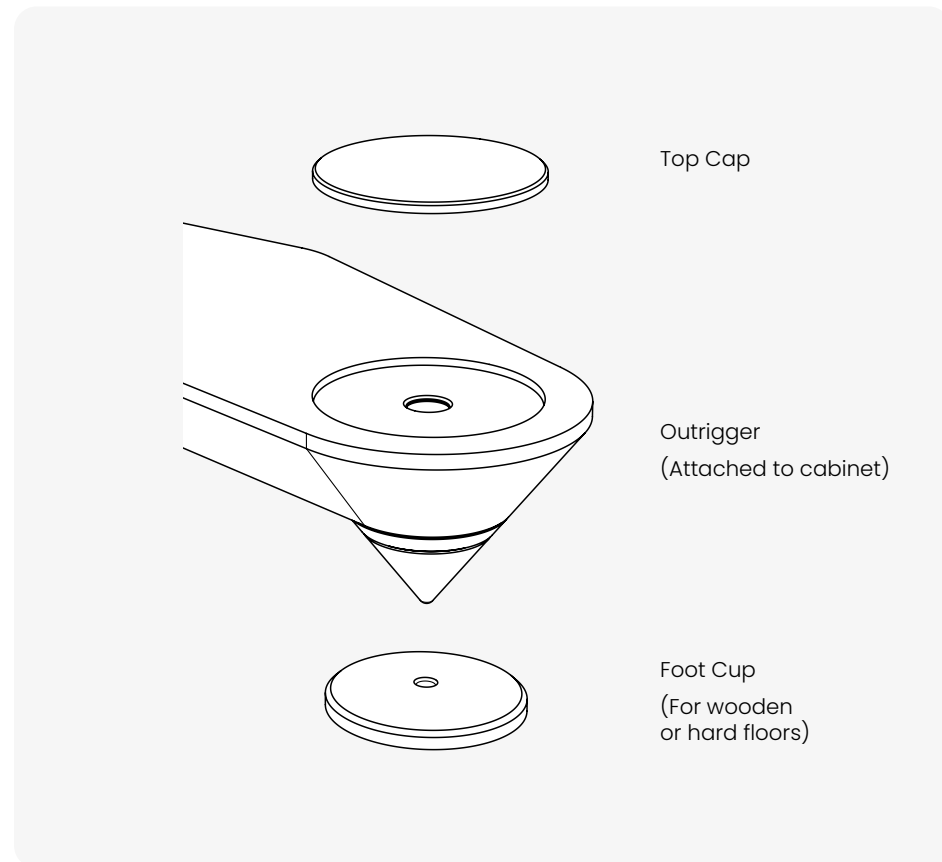

Levelling the speaker

You can check that the loudspeaker is level on all sides by using a spirit level (not supplied). If it's slightly uneven, remove the top cap (held in place magnetically) and unscrew the foot at the lowest point using the supplied hex key as illustrated below and check again. Continue this process until the cabinet is fully level, then replace the top cap.

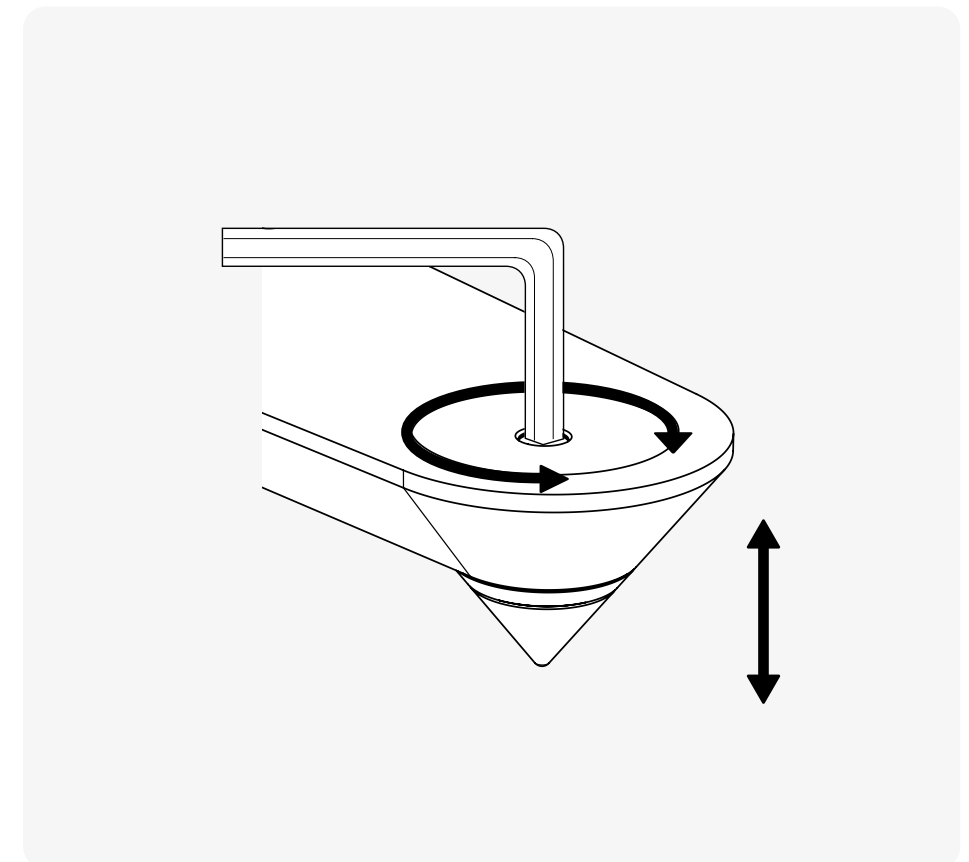

Bi-wiring

Bi-wiring is accomplished by connecting separate pairs of loudspeaker cables to the terminals on the loudspeaker from a single pair of connections on the amplifier. In the case of Hyphn, the bottom terminals connect to the bass driver(s) and the top terminals connect to the mid and tweeter.

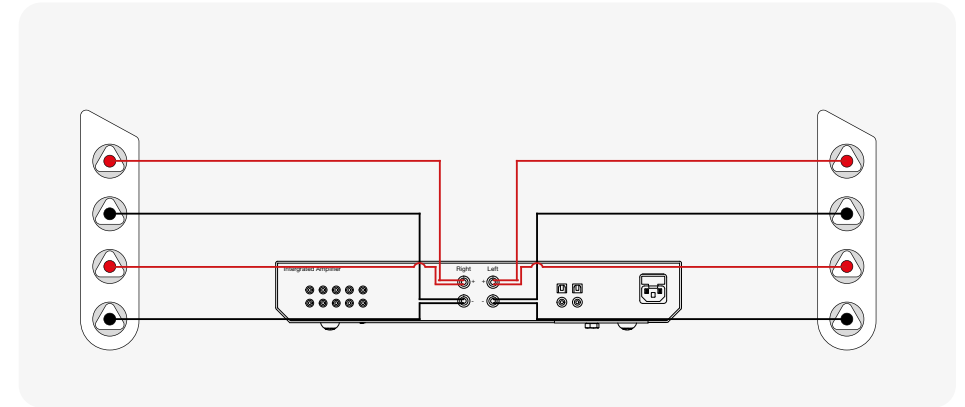

Bi-amping

Bi-amping is the same as bi-wiring, except you are introducing a second amplifier into the equation.

In order to bi-amp, you must connect a set of loudspeaker cables to the top terminals on the loudspeaker from one amplifier and another set of loudspeaker cables to the bottom terminals from the second amplifier.

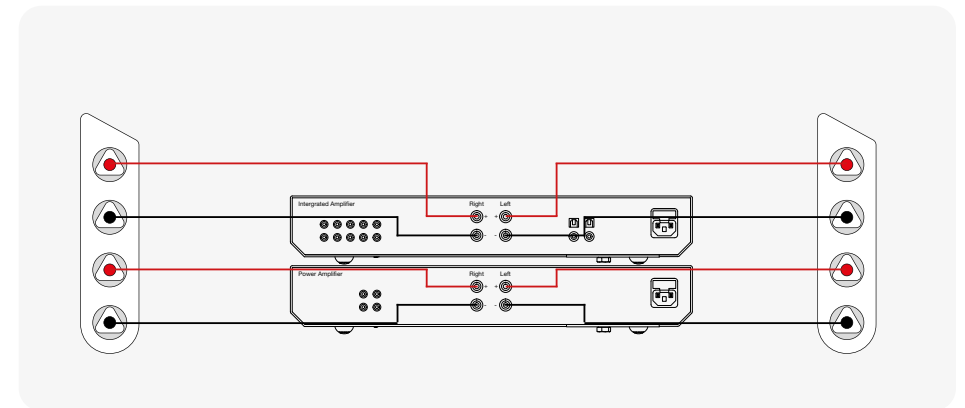

Running-in your loudspeakers

Run your loudspeakers in by playing music at low-mid listening levels for approximately 50-70 hours play time. You may find the sound will continue to improve, even after the 70 hour mark.

This can be done naturally over time: like a fine wine the performance will improve with age.

Upkeep of cabinets

The finish of the cabinet can be maintained by regular dusting using a soft or micro fibre cloth. The drive units should only be cleaned with a damp cloth, if more than normal dusting is required.

Be careful not to damage the driver units whilst cleaning.

Never use solvents or aggressive cleaning/polishing agents on your Hyphn loudspeakers. When in doubt, test the cleaning product on an inconspicuous area on the cabinet, and let it sit for several days before committing to its use on visible portions of the cabinet.

Warranty

In the unlikely event that there is a defect with this product, it is covered by the Monitor Audio manufacturer's warranty, provided that the product was supplied by an authorised Monitor Audio retail specialist.

For the period of cover please refer to the product page on our website at monitoraudio.com

Register your Hyphn speakers
to ensure the best possible product and customer support



Register your speakers using the QR code
or visit monitoraudio.com/registration

Specifications

Model	Hyphn
Sensitivity (2.83 Vrms @ 1 m)	86 dB
Recommended Amplifier Power (RMS into 4 Ohm, Music Signal)	200 - 1,600 W
Continuous Power Handling (RMS into Nominal Impedance, Pink Noise with 6 dB Crest Factor)	800 W
Nominal Impedance	4 Ohm
Minimum Impedance (20 Hz to 20 kHz)	3.5 Ohm @ 2.2 kHz
Drive Unit Complement	4 x 8" (203 mm) RDT III Bass Driver 6 x 2" (50 mm) RDT III Midrange Driver 1 x MPD III Transducer
Frequency Response (In-room, -6 dB)	18 Hz - 60 kHz
Maximum Peak SPL (single speaker @1 m Z-Weighted)	129 dB
System Format	3-Way
Bass Alignment	Bass Reflex
Port Tuning Frequency	25 Hz
Crossover Frequencies	350 Hz, 3.7 kHz
External Dimensions (Inc. plinth) (H x W x D)	1392 x 502 x 520 mm (54 ^{13/16} x 19 ^{3/4} x 20 ^{1/2} "
Weight (Inc. Outrigger Feet)	106.9 kg (235 lbs 10.7 oz)

Listen Again.

Monitor Audio Ltd.
24 Brook Road
Rayleigh, Essex
SS6 7XJ
England
Tel: +44 (0)1268 740580
Email: info@monitoraudio.group

[monitoraudio.com](https://www.monitoraudio.com)